

ET5X

Enterprise Tablet



User Guide for Android™ Version 6.0.1



ZEBRA

Copyright

© 2018 ZIH Corp. and/or its affiliates. All rights reserved. ZEBRA and the stylized Zebra head are trademarks of ZIH Corp., registered in many jurisdictions worldwide. Android and Google are trademarks of Google Inc. All other trademarks are the property of their respective owners.

COPYRIGHTS & TRADEMARKS: For complete copyright and trademark information, go to www.zebra.com/copyright.

WARRANTY: For complete warranty information, go to www.zebra.com/warranty.

END USER LICENSE AGREEMENT: For complete EULA information, go to www.zebra.com/eula.

Terms of Use

- Proprietary Statement

This manual contains proprietary information of Zebra Technologies Corporation and its subsidiaries (“Zebra Technologies”). It is intended solely for the information and use of parties operating and maintaining the equipment described herein. Such proprietary information may not be used, reproduced, or disclosed to any other parties for any other purpose without the express, written permission of Zebra Technologies.

- Product Improvements

Continuous improvement of products is a policy of Zebra Technologies. All specifications and designs are subject to change without notice.

- Liability Disclaimer

Zebra Technologies takes steps to ensure that its published Engineering specifications and manuals are correct; however, errors do occur. Zebra Technologies reserves the right to correct any such errors and disclaims liability resulting therefrom.

- Limitation of Liability

In no event shall Zebra Technologies or anyone else involved in the creation, production, or delivery of the accompanying product (including hardware and software) be liable for any damages whatsoever (including, without limitation, consequential damages including loss of business profits, business interruption, or loss of business information) arising out of the use of, the results of use of, or inability to use such product, even if Zebra Technologies has been advised of the possibility of such damages. Some jurisdictions do not allow the exclusion or limitation of incidental or consequential damages, so the above limitation or exclusion may not apply to you.

Revision History

Changes to the original guide are listed below:

Change	Date	Description
-01 Rev A	6/2017	Initial release
-02 Rev A	3/2018	Correct CPU bit size. Add information for BSP 02-14-xx.

Table of Contents

Copyright	2
Terms of Use	2
Revision History	2

Table of Contents.....	3
-------------------------------	----------

About This Guide

Introduction	9
Configurations	9
Software Versions	10
Chapter Descriptions	10
Notational Conventions	11
Related Documents and Software	11
Service Information	11
Provide Documentation Feedback	12

Getting Started

Introduction	13
Unpacking	13
Features	14
Getting Started	16
Installing a micro SIM Card (ET55 Only)	16
Install a microSD Card	20
Charging the ET5X	21
Google Account Setup	21
Removing the microSD Card	22
Turning Off the ET5X	22
Device Sensors	24
Turning Off the Display	25
Battery Management	25
Monitor Battery Usage	25
Low Battery Notification	26
Battery Optimization	27
Turning Off the Radios	27
Setting the Date and Time	27

Table of Contents

Display Setting	28
Setting the Screen Brightness	28
Setting Screen Timeout Setting	28
Setting Font Size	28
Setting Screen Rotation	29
Touch Mode	29
General Sound Setting	30
Sound	31
Notification	32
Advanced	32
Do Not Disturb Feature	32
Limit Sounds and Vibrations	32
Automatically Block Sounds and Vibrations	34
Silence Sounds During Certain Times	34
Silence Sounds During Events and Meetings	34
Turn Sounds Back On	34
Override Do Not Disturb for Specific Apps	34
Using the Tablet	
Introduction	36
Google Mobile Services	36
Home Screen	37
Status Bar	38
Status Icons	39
Notification Icons	40
Managing Notifications	41
Quick Settings	41
Application Shortcuts and Widgets	42
Adding an Application or Widget to the Home Screen	42
Moving Items on the Home Screen	42
Removing an App or Widget from the Home Screen	42
Folders	42
Using the Touchscreen	42
Using the On-screen Keyboard	43
Editing Text	43
Entering Numbers, Symbols and Special Characters	43
Applications	44
Accessing Applications	47
Switching Between Recent Applications	49
Un-Locking the Screen	49
Suspend Mode	52
Rebooting the ET5X	52
Soft Reset	52
Hard Reset	53
Applications	
Introduction	54
File Browser	54
DataWedge Demonstration	56

Table of Contents

Camera	58
Taking Photos	58
Recording Videos	59
Camera Settings	59
Resolution & quality	60
Save location	61
Advanced	61
Photo Settings	61
Rear Camera	61
Front Camera	61
Video Settings	61
Rear Camera	62
Front Camera	62
Gallery	63
Working with Albums	64
Share an Album	64
Get Album Information	64
Deleting an Album	64
Working with Photos	65
Viewing and Browsing Photos	65
Rotating a Photo	66
Cropping a Photo	66
Setting a Photo as a Contact Icon	66
Get Photo Information	67
Share a Photo	67
Deleting a Photo	67
Working with Videos	68
Watching Videos	68
Sharing a Video	68
Deleting a Video	68
Contacts	69
Adding a Contact	69
Editing Contacts	69
Deleting Contacts	69
Email	70
Creating an Email Message	70
Viewing an Email Message	71
Replying to a Message	71
Email Setup	72
Setting Up an IMAP or POP Account	72
Setting Up an Exchange Account	72
Editing an Email Account	73
RxLogger	74
Elemex	75
Disabling Elemex Data Collection	75
Enabling Elemex Data Collection	76
Google Installed Application	77
Wireless	
Wireless Wide Area Networks	78

Table of Contents

Sharing the Mobile Data Connection	78
USB Tethering	78
Bluetooth Tethering	79
Portable Wi-Fi Hotspot	79
Data Usage	80
Set Data Usage Warning	81
Set Auto-Sync	81
Disabling Data When Roaming	81
Locking the SIM Card	82
Editing the Access Point Name	82
Wireless Local Area Networks	83
Scan and Connect to a Wi-Fi Network	83
Configuring a Wi-Fi Network	84
Manually Adding a Wi-Fi Network	85
Configuring for a Proxy Server	86
Configuring the Device to Use a Static IP Address	87
Advanced Wi-Fi Settings	88
Additional Settings	88
Remove a Wi-Fi Network	90
Wi-Fi Advanced Features	90
Zebra Mobility Extensions	91
Bluetooth	91
Adaptive Frequency Hopping	91
Security	92
Bluetooth Profiles	92
Bluetooth Power States	93
Bluetooth Radio Power	93
Enabling Bluetooth	93
Disabling Bluetooth	93
Discovering Bluetooth Device(s)	93
Changing the Bluetooth Name	94
Connecting to a Bluetooth Device	94
Selecting Profiles on the Bluetooth Device	94
Unpairing a Bluetooth Device	95
Near Field Communications	95
Reading NFC Cards and RFID Tags	95
Data Capture	
Expansion Back	97
RS507 Hands-Free Imager	97
RS6000 Bluetooth Ring Scanner	98
Scanning Considerations	98
Imaging	99
Bar Code Capture Using the SE4750 Expansion Back	99
Bar Code Capture Using RS507 Hands-Free Imager	100
Bar Code Capture Using RS6000 Bluetooth Scanner	101
Bar Code Capture with DS36X8 Scanner	102
Pairing the RS507/RS6000 Using SSI	104
Pairing the RS507/RS6000 Using HID	104
Connecting a DS3608 USB Scanner	105

Table of Contents

Connecting Using Simple Serial Interface	105
Connecting Using HID Mode	105
Pairing a DS3678 Bluetooth Scanner	106
Pairing Using Simple Serial Interface	106
Pairing a DS3678 Scanner Using Human Interface Device	107
Accessories	
Introduction	108
Charge Only Cradle	111
Installing the Insert	112
Charging the ET5X	112
Communication and Charging Cradle	114
Installing the Insert	115
Charging the ET5X	116
Rugged Communication and Charging Cradle	118
Charging the ET5X	119
4-Slot Charge Only Cradle	122
Insert Installation	122
Power Setup	123
Insert Tablet into Slot	124
ET5X without Rugged Frame	124
ET5X with Rugged Frame	124
Charging th Battery	125
Rugged Charge Connector	126
Power Pack	128
Charging the Power Pack	129
Using Cradle	129
Using USB Power Adapter	129
Using the 4-Slot Battery Charger	130
Charging the Power Pack	130
Maintenance and Troubleshooting	
Introduction	132
Maintaining the ET5X	132
Battery Safety Guidelines	132
Cleaning	133
Materials Required	133
Cleaning the ET5X	133
Housing	133
Display	133
Power Connector	133
Cleaning Cradle Connectors	134
Cleaning Frequency	134
Troubleshooting	135
Diagnostic Tool	135
ET5X	135
Charge Only Cradle	136
Communication and Charging Cradles	137
Expansion Backs	137

Table of Contents

4-Slot Charge Only Cradle	138
Charging Adapter	139
4-Slot Battery Charger	139
Specifications	
Technical Specifications	140
ET5X	140

About This Guide

Introduction

This guide provides information about using the ET5X tablet and accessories.



NOTE Screens and windows pictured in this guide are samples and can differ from actual screens.

Configurations

This guide covers the following configurations:

Table 1 *Configurations*

Configuration	Operating System	Radios	Display	Memory	Data Capture
ET50PE	Version 6.0.1	WLAN: 802.11a/b/g/n/ac/d/h/i WPAN: Bluetooth	8" color	2 GB RAM/ 32 GB Flash	SE4750 Expansion Back, RS507 Hands-free Imager
ET50PT	Version 6.0.1	WLAN: 802.11a/b/g/n/ac/d/h/i WPAN: Bluetooth	10" color	2 GB RAM/ 32 GB Flash	SE4750 Expansion Back, RS507 Hands-free Imager
ET55BE	Version 6.0.1	WLAN: 802.11a/b/g/n/ac/d/h/i WPAN: Bluetooth WWAN: NA - LTE	8" color	2 GB RAM/ 32 GB Flash	SE4750 Expansion Back, RS507 Hands-free Imager



Table 1 Configurations (Continued)

Configuration	Operating System	Radios	Display	Memory	Data Capture
ET55BT	Version 6.0.1	WLAN: 802.11a/b/g/n/ac/d/h/i WPAN: Bluetooth WWAN: NA - LTE	10" color	2 GB RAM/ 32 GB Flash	SE4750 Expansion Back, RS507 Hands-free Imager
ET55TE	Version 6.0.1	WLAN: 802.11a/b/g/n/ac/d/h/i WPAN: Bluetooth WWAN: ROW - LTE	8" color	2 GB RAM/ 32 GB Flash	SE4750 Expansion Back, RS507 Hands-free Imager
ET55TT	Version 6.0.1	WLAN: 802.11a/b/g/n/ac/d/h/i WPAN: Bluetooth WWAN: ROW - LTE	10" color	2 GB RAM/ 32 GB Flash	SE4750 Expansion Back, RS507 Hands-free Imager

Software Versions

To determine the current software versions touch  >  >  **About tablet**.

- **Model number** - Displays the model number.
- **Android version** - Displays the operating system version.
- **Android Security Patch Level** - Displays the current Android security patch level. installed on the tablet.
- **Kernel version** - Displays the kernel version number.
- **Build number** - Displays the software build number.

To determine the device serial number touch  >  >  **About tablet** > **Status** > **Serial number**.

Chapter Descriptions

Topics covered in this guide are as follows:

- [Getting Started](#), provides information on getting the tablet up and running for the first time.
- [Using the Tablet](#), explains how to use the tablet. This includes instructions for powering on and resetting the tablet, entering and capturing data.
- [Applications](#), provides information on using applications installed on the ET5X.
- [Wireless](#), explains how to perform Bluetooth functionality on the tablet.
- [Data Capture](#), explains how to capture data using the optional scanners.
- [Accessories](#), describes the accessories available for the tablet and how to use the accessories with the tablet.
- [Maintenance and Troubleshooting](#), includes instructions on cleaning and storing the tablet, and provides troubleshooting solutions for potential problems during tablet operation.
- [Specifications](#), includes a table listing the technical specifications for the tablet.

Notational Conventions

The following conventions are used in this document:

- “Tablet” refers to the Zebra ET5X tablet.
- **Bold** text is used to highlight the following:
 - Dialog box, window and screen names
 - Drop-down list and list box names
 - Check box and radio button names
 - Icons on a screen
 - Key names on a keypad
 - Button names on a screen.
- Bullets (•) indicate:
 - Action items
 - Lists of alternatives
 - Lists of required steps that are not necessarily sequential.
- Sequential lists (e.g., those that describe step-by-step procedures) appear as numbered lists.

Related Documents and Software

The following documents provide more information about the ET5X tablets.

- ET5X Quick Reference Guide, p/n MN001844Axx
- ET5X Integrator Guide for Android Version 6.0.1, p/n MN-003016-xx
- RS507 Hands-free Imager Product Reference Guide, p/n 72E-120802-xx

For the latest version of this guide and all guides, go to: www.zebra.com/support.

Service Information

If you have a problem with your equipment, contact Zebra Global Customer Support for your region. Contact information is available at: www.zebra.com/support.

When contacting support, please have the following information available:

- Serial number of the unit
- Model number or product name
- Software type and version number.

Zebra responds to calls by email, telephone or fax within the time limits set forth in support agreements.

If your problem cannot be solved by Zebra Customer Support, you may need to return your equipment for servicing and will be given specific directions. Zebra is not responsible for any damages incurred during shipment if the approved shipping container is not used. Shipping the units improperly can possibly void the warranty.

If you purchased your Zebra business product from a Zebra business partner, contact that business partner for support.

Provide Documentation Feedback

If you have comments, questions, or suggestions about this guide, send an email to EVM-Techdocs@zebra.com.

Getting Started

Introduction

This chapter explains how to set the device up for the first time.

Unpacking

Carefully remove all protective material from around the ET5X and save the shipping container for later storage and shipping.

Verify that you received all equipment listed below:

- Tablet with lithium-ion battery
- Quick Reference Guide.

Inspect the equipment for damage. If you are missing any equipment or if you find any damaged equipment, contact the Zebra Support Center immediately. See [Service Information on page 11](#) for contact information.

Features

Figure 1 Front View

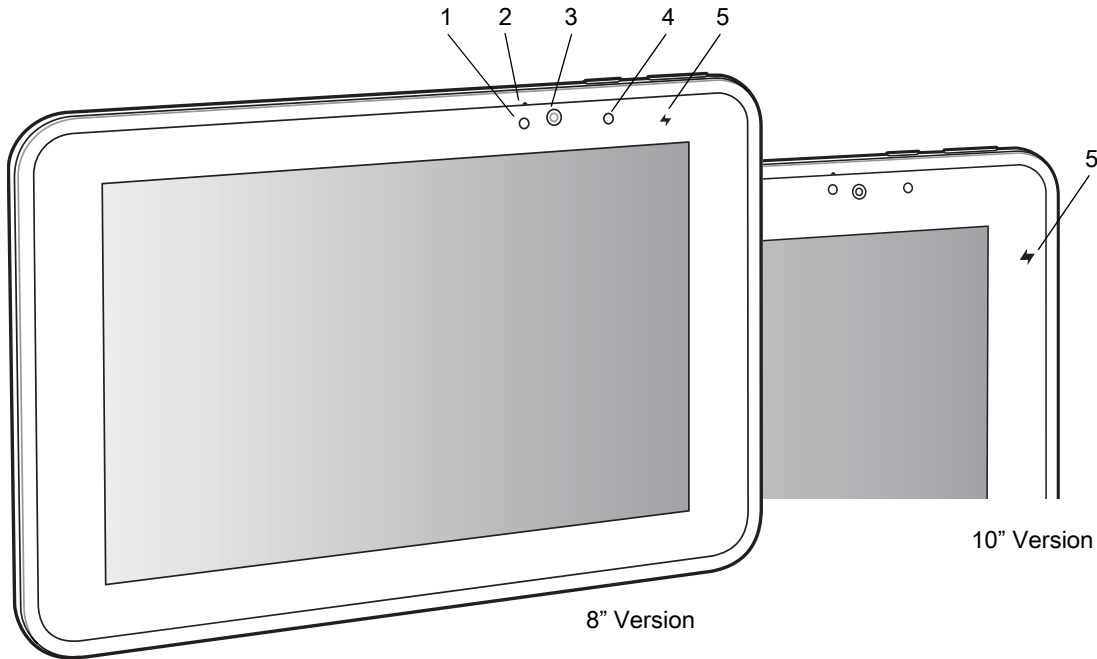

Table 2 Front View

Item	Description
1	Ambient Light Sensor - Recognizes the ambient light and adjusts the display brightness (if enabled).
2	Front Microphone - Use for audio recording.
3	Front Facing Camera - 2 MP camera for capturing images and video.
4	Camera Indicator LED - Lights red when the camera is activate. Momentarily lights red when the device boots and shuts down.
5	Charging Indicator LED - Indicates charging status. <ul style="list-style-type: none"> • OFF - device is not connected to charger. • ORANGE - device is charging. • GREEN - device is connected and fully charged. • RED - charge error.

Figure 2 Back View

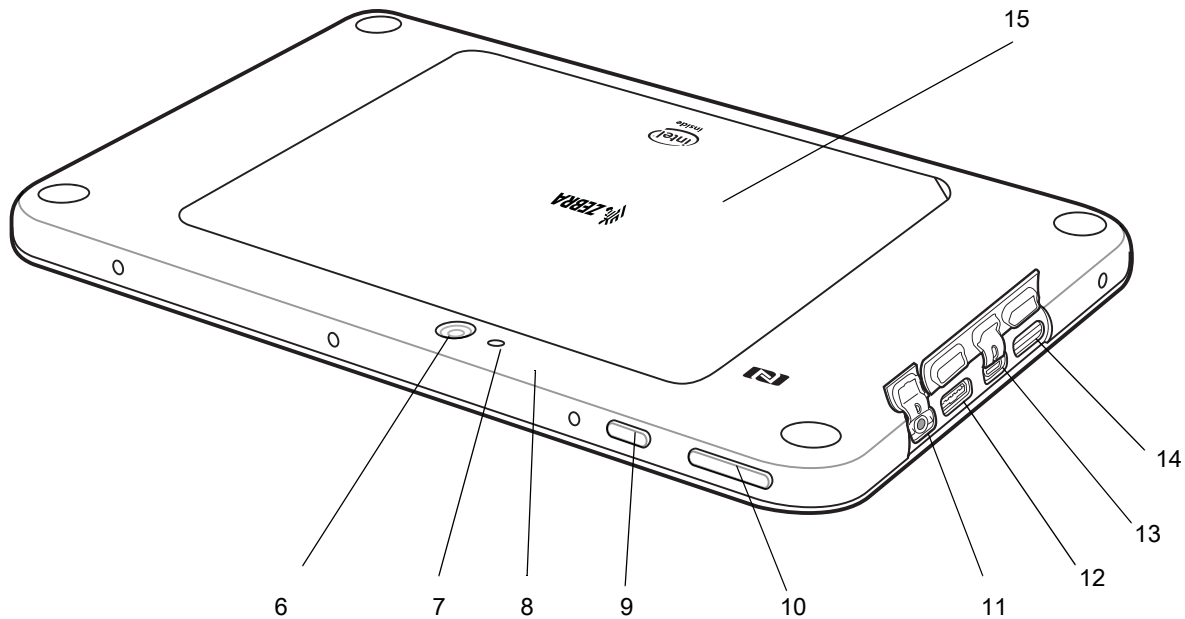

Table 3 Back View

Item	Description
6	Rear Camera - 8MP auto-focus camera for capturing high resolution images and video.
7	Camera LED Flash - Provides illumination for the camera.
8	Rear Microphone - Use during video recordings.
9	Power Button - Push once to start the ET5X; push it again to enable sleep mode. Push and hold it to shut down the ET5X.
10	Volume Key - Push the left side to reduce the volume. Press the right side to increase the volume.
11	3.5 mm Audio Jack - Use to connect to headset with microphone.
12	USB 2.0 Port - Provides input for USB devices.
13	Micro USB Interface - Provides for charging the ET5X using USB cable and power supply and communication with host computer.
14	MicroSD Card Slot - Provides storage for microSD Card (SDXC type up to 2 TB).
15	Back Cover - Covers the service replaceable battery.

Figure 3 Bottom View

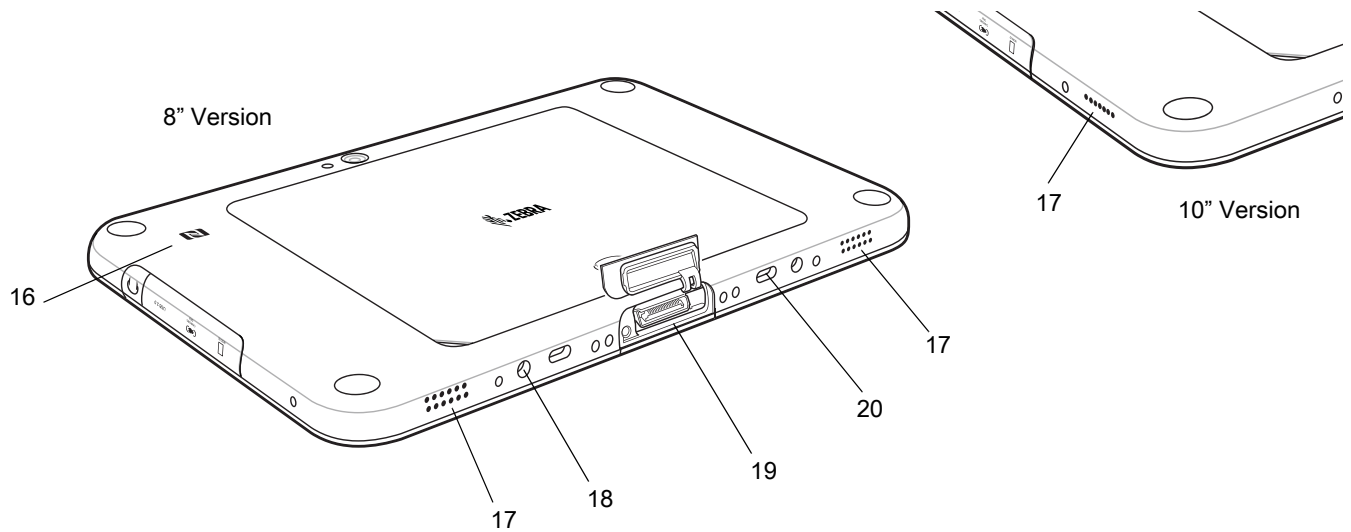

Table 4 Bottom View

Item	Description
16	NFC Antenna Position - Use to read NFC cards and RFID tags.
17	Stereo Speakers - Provides audio playback.
18	Alignment Holes - Use to align the tablet with the cradles.
19	Docking Connector - Interfaces with the cradle.
20	Latching Slots - Provides locking mechanism when docking the tablet to the Communication and Charging Cradles.

Getting Started

In order to start using the ET5X for the first time:

- install the micro SIM Card (ET55 only)
- install microSD card (optional)
- start the ET5X
- configure the ET5X.

The main battery can be charged before or after it is installed. Use one of the spare battery chargers to charge the main battery (out of the ET5X), or one of the cradles to charge the main battery installed in the ET5X.

Installing a micro SIM Card (ET55 Only)



CAUTION: Do not use nano to micro SIM card adapters.

To install a micro SIM card:

1. Press the Power button to turn off the ET55.
2. Lift the notched corner of the battery cover.

Figure 4 Removing the Battery Cover

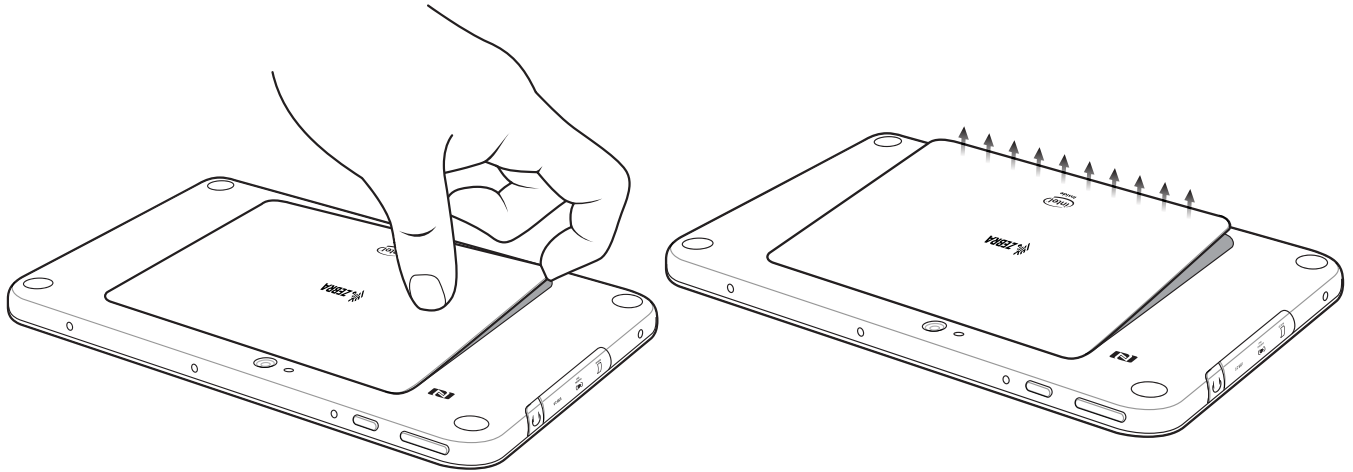

3. Carefully lift the battery cover off the ET55.
4. On the 8" version, push the two locking tabs up, then pull up on the tab to remove battery.
On the 10" version, push the two locking tabs up (1), then, using index fingers, lift the battery up (2).

Figure 5 Removing the Battery - 8"

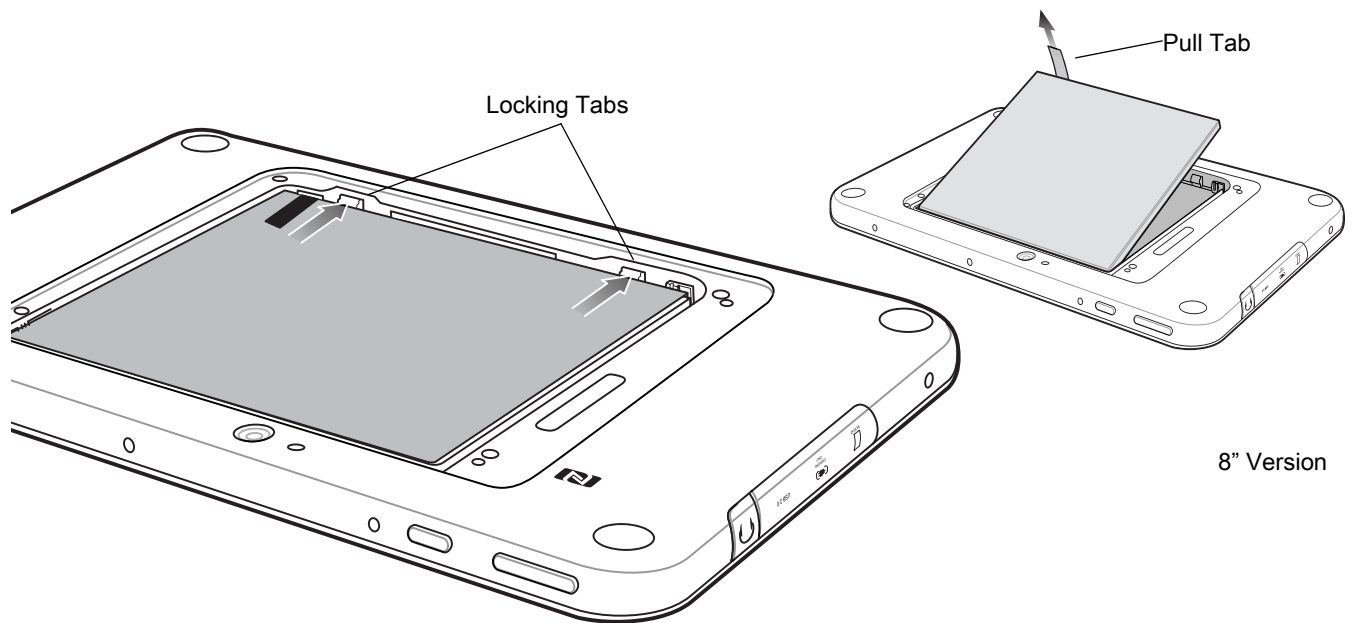
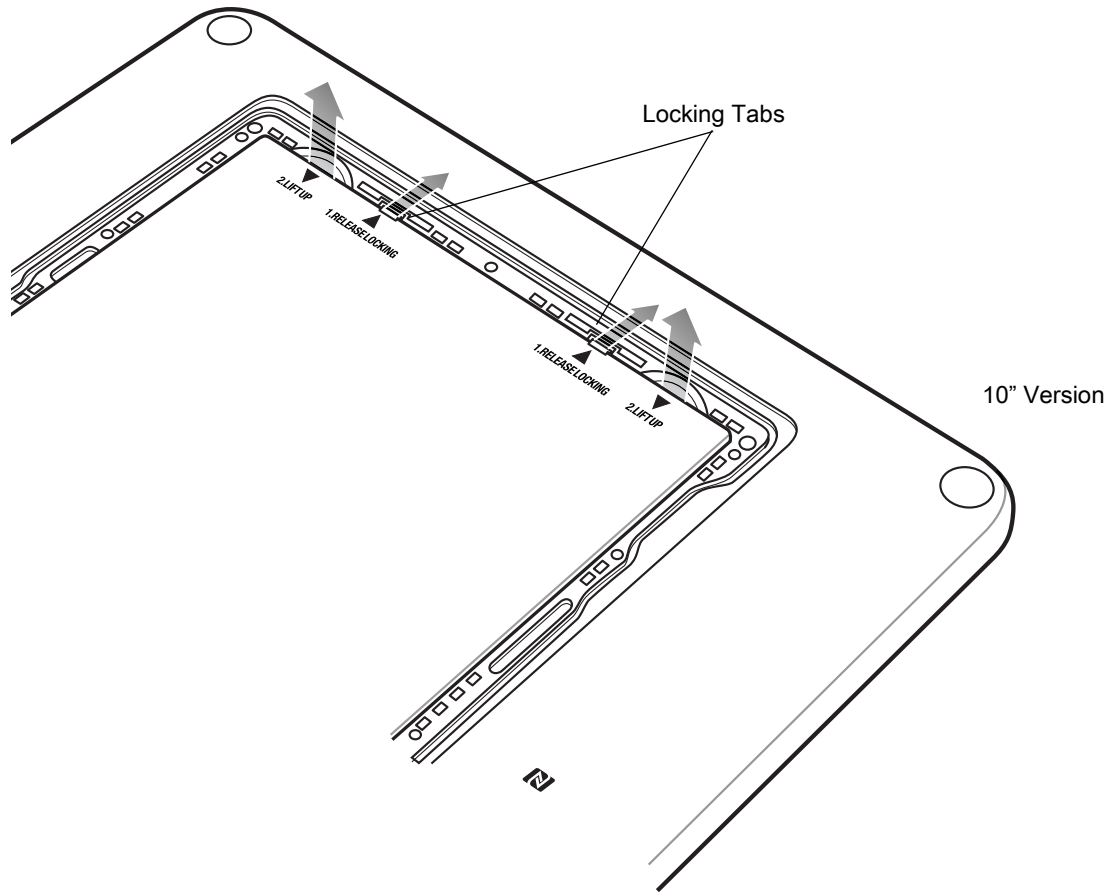
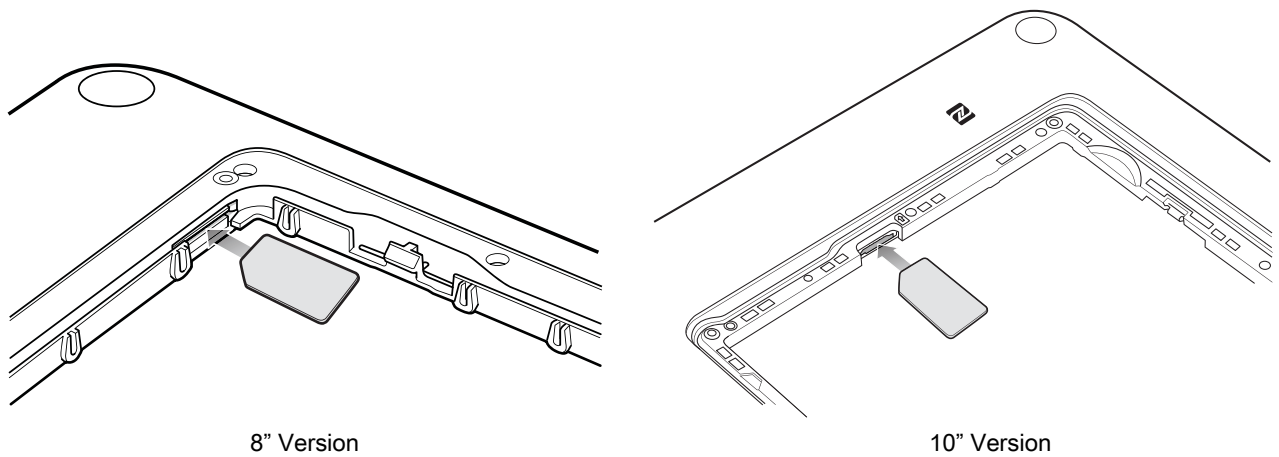

Figure 6 Removing the Battery - 10"



5. Insert the micro SIM card with contacts facing down.

Figure 7 Insert micro SIM Card



6. Push the micro SIM card in and ensure that it locks into place.
7. Replace the battery.
On the 10" version, ensure that the two battery latches engage.

Figure 8 Insert Battery

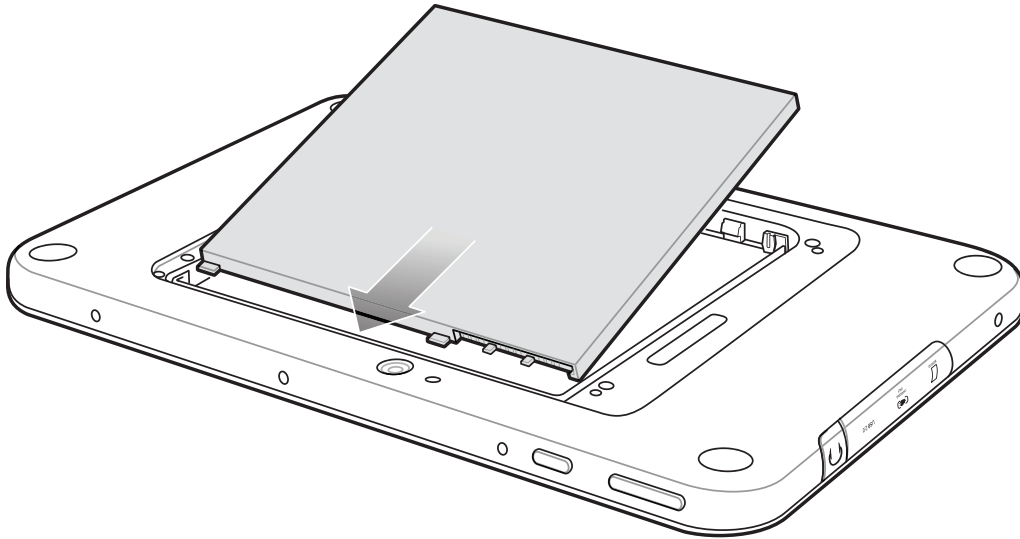

CAUTION: Be aware of the orientation of the battery cover. Failure to replace the battery cover properly may damage the battery cover.

8. Align the tabs on the underside of the cover with the slot around the battery well. Make sure that the notch on the battery cover is at the bottom left corner of the ET55.

Figure 9 Align Battery Cover

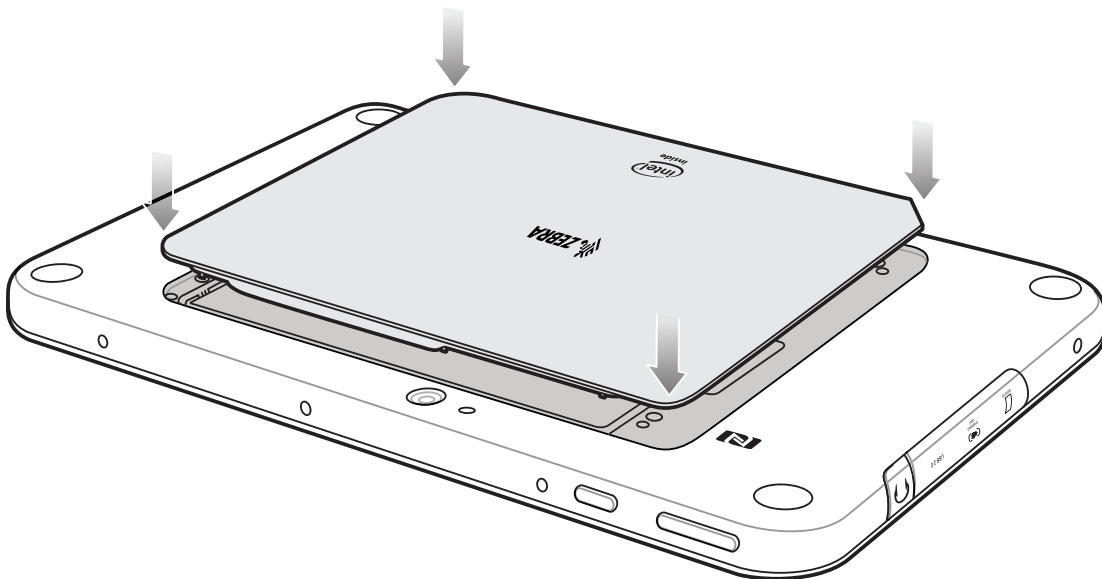

9. Carefully press down around the edge of the cover. Make sure that the cover is seated properly.

Figure 10 Press Down on Battery Cover

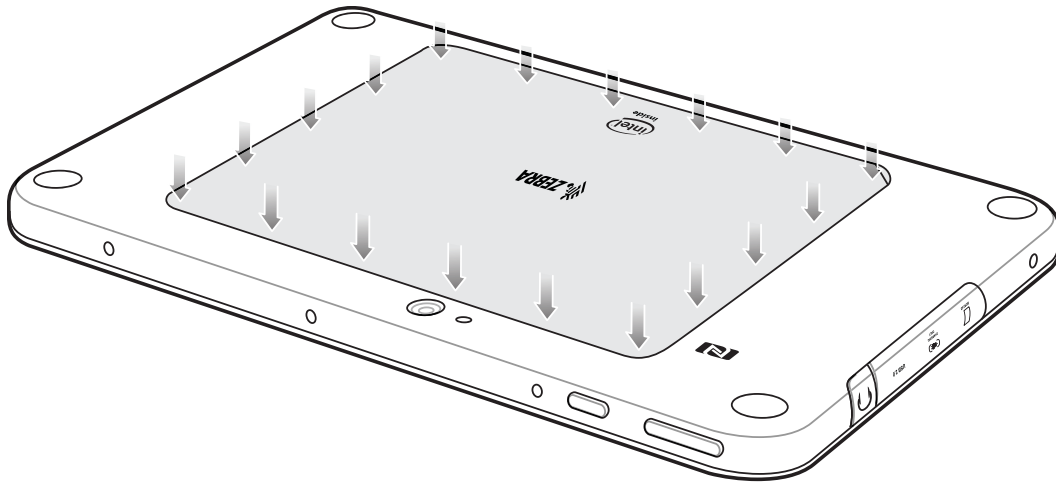

10. Press Power button to turn on the ET55.

Install a microSD Card

To install a microSD card:

1. Open access door.

Figure 11 Open Access Door

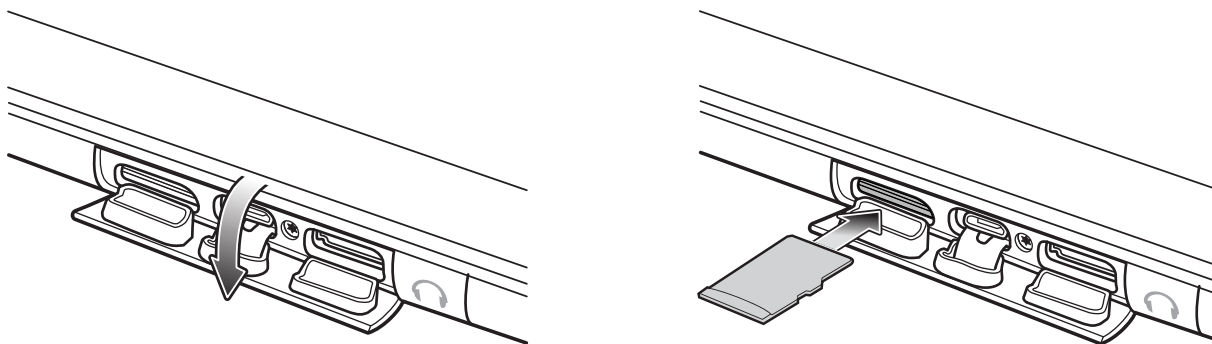

2. Insert microSD card into slot with contacts facing down.
3. Press the card in to ensure that it is seated properly.
4. Close access door.

Figure 12 Close Access Door

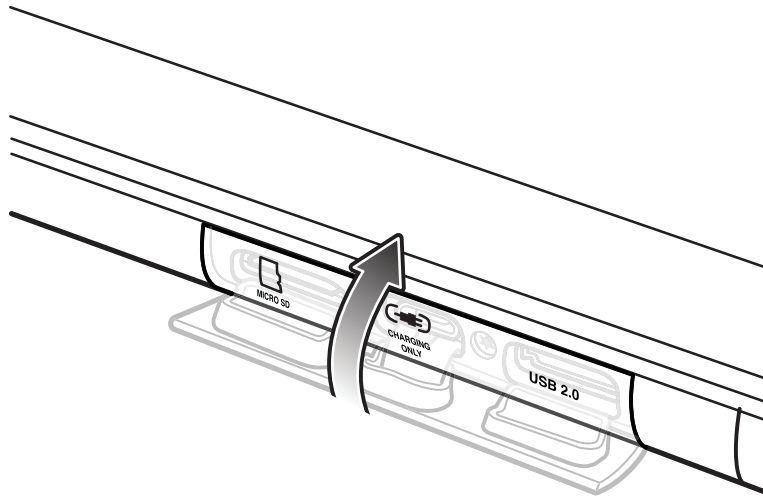

Charging the ET5X



NOTE: Use only Zebra approved accessories listed in this guide when charging the ET5X.

Use one of the available accessories to charge the ET5X. Refer to [Accessories](#) for charging accessories.

The 8" tablet main battery charges from fully depleted to 90% in approximately 2.5 hours and from fully depleted to 100% in approximately 3.5 hours.

The 10" tablet main battery charges from fully depleted to 90% in approximately three hours and from fully depleted to 100% in approximately four hours.



NOTE: The Charging indicator only illuminates when the ET5X is connected to AC power.

Table 5 Charging Indicator

LED	Indication
Off	ET5X is not in cradle. ET5X is not seated properly. Cradle is not powered.
Orange	ET5X is charging.
Green	Charging complete.
Red	Error in charging; check placement of the ET5X.

Google Account Setup



NOTE: The ET5X with GMS has to be connected to the internet, through Wi-Fi or cellular data (ET55 only), in-order to set up a Google account.

The first time the ET5X starts, the Setup Wizard displays. Follow the on-screen instructions to set up a Google account, configure Google Wallet for purchasing items from the Play Store, entering your personal information, and enabling backup/restore features.

Removing the microSD Card

To remove the microSD card:

1. Swipe down with two fingers from the status bar to open the quick access panel.
2. Touch .
3. Touch **Storage & USB**.
4. Touch **Unmount**.
5. Open access door.

Figure 13 Open Access Door



6. Press on the microSD card to release it.
7. Close access door.

Figure 14 Close Access Door

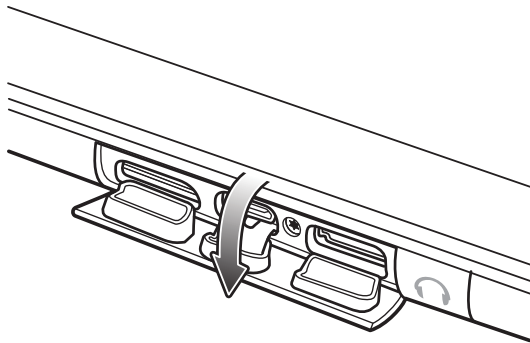
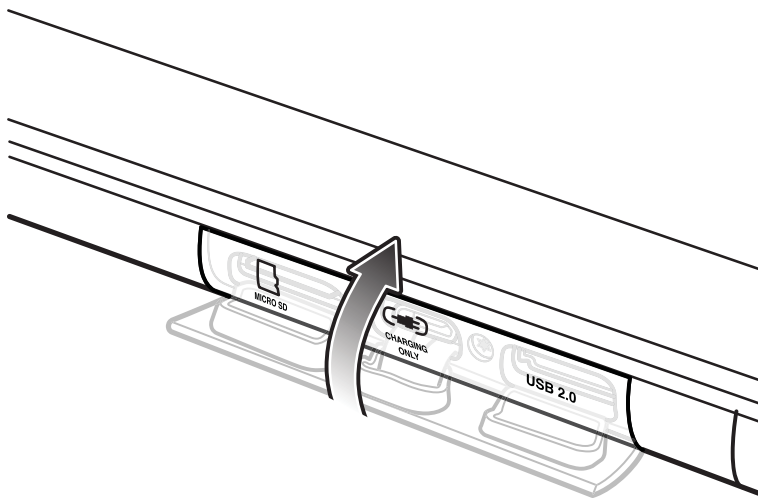

Turning Off the ET5X

To turn off the device:

1. Press and hold the power button until the menu appears.

Figure 15 Power Menu

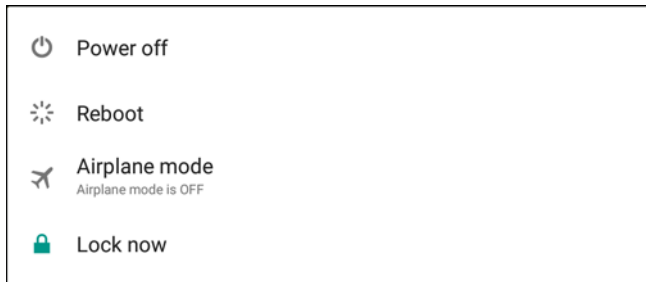

2. Touch **Power off**.

Device Sensors

By default, the two ET5X sensors (gyroscope and accelerometer) are disabled. The  icon appears in the Status Bar indicating that these sensors are disabled. To use the device sensors for screen rotation and positioning, turn on the sensors.

1. Swipe down from status bar to view the Notification Panel.

Figure 16 Rotation Disabled Notification

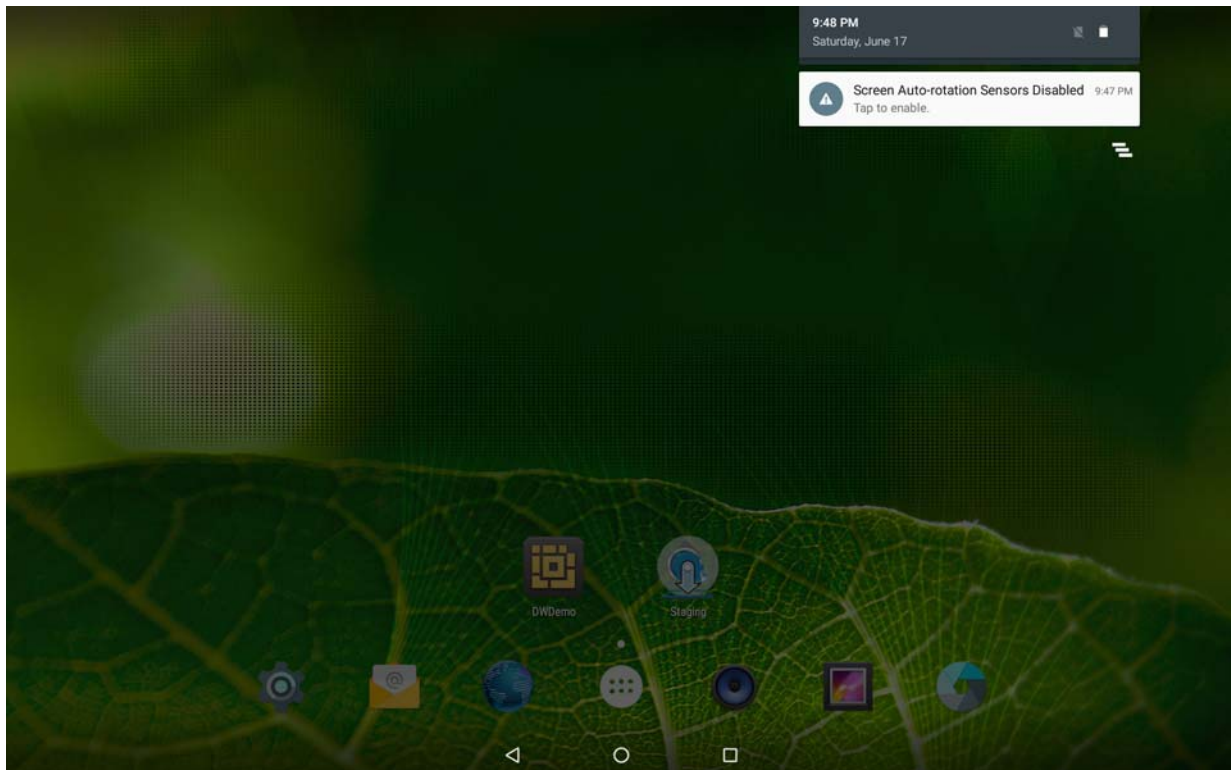

2. Touch **Screen Auto-rotation Sensors Disabled** notification. The **Sensors** screen appears.

Figure 17 Sensors Settings

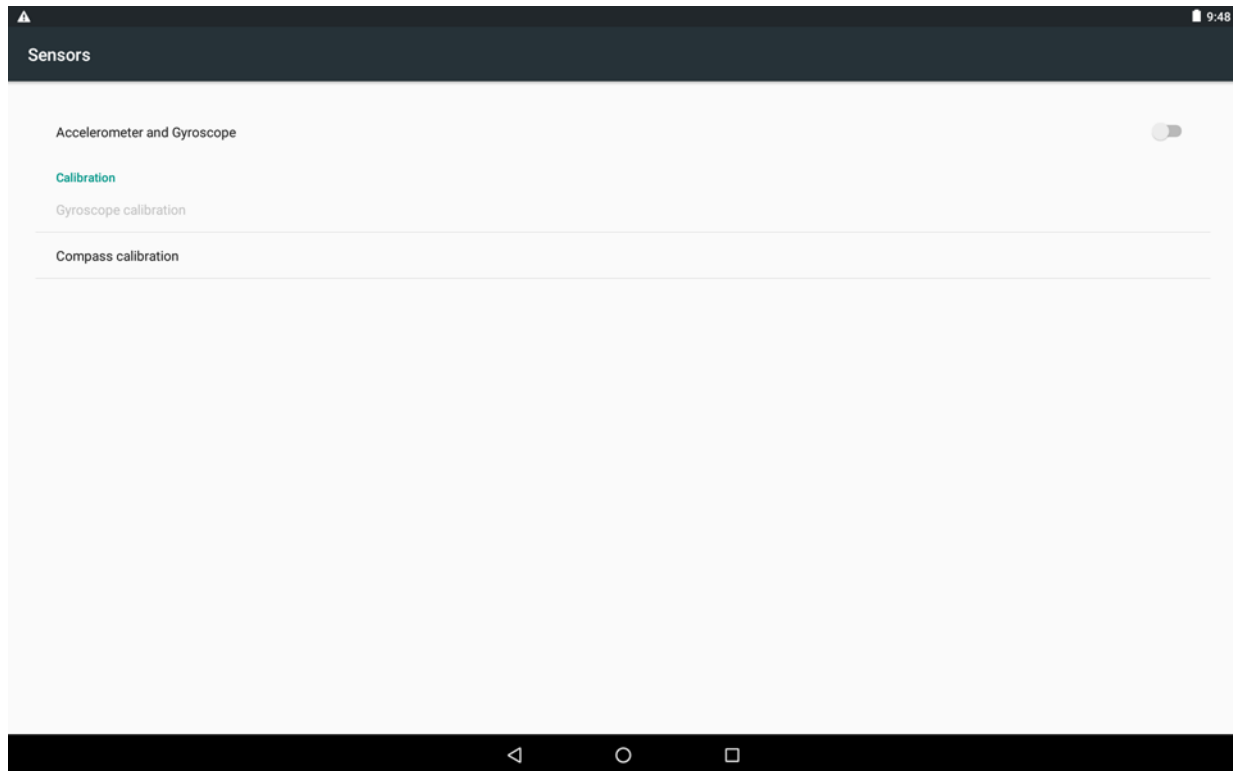



3. Touch the switch in the top right corner of the screen to enable the sensor settings. The **Restart now?** dialog appears.
4. Touch **OK**. The device shuts down and then reboots. After reboot, all sensors are enabled.

Turning Off the Display

To turn off the display press and release the power button.

Battery Management

To check the charge status of the main battery:

1. Swipe down with two fingers from the status bar to open the quick access panel and then touch .
2. Touch  **About tablet > Status**.

Battery status indicates that the battery is discharging (**Not charging**) or charging in a cradle (**Charging on AC**) and **Battery level** lists the battery charge (as a percentage of fully charged).

Monitor Battery Usage

The Battery screen lists which applications consume the most battery power. Also use it to turn off applications that were downloaded if they are consuming too much power.

1. Swipe down with two fingers from the status bar to open the quick access panel and then touch .

2. Touch  **Battery**.

Figure 18 Battery Screen

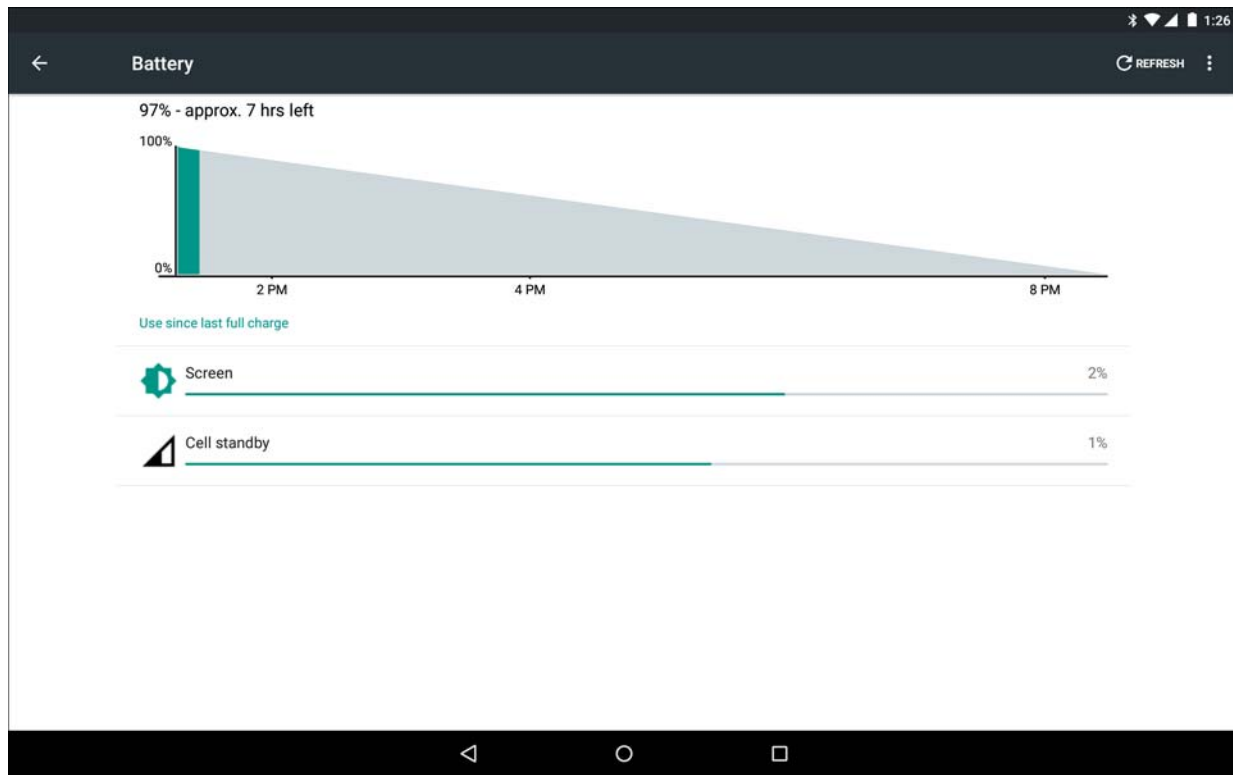

 **NOTE** Battery life dependent upon current running applications.

The Battery screen lists the applications using the battery. The discharge graph at the top of the screen shows the rate of the battery discharge since last charged (short periods of time when connected to a charger are shown as thin green lines at the bottom of the chart), and how long it has been running on battery power.

Touch an application in the Battery screen to display details about its power consumption. Different applications display different information. Some applications include buttons that open screens with settings to adjust power use.

Low Battery Notification

When the battery charge level drops below 15%, the ET5X displays a notice to connect the ET5X to power. Place the ET5X into a cradle to charge the battery.

Figure 19 Low Battery Notification

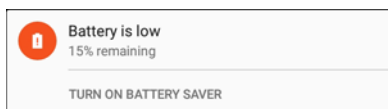

When the battery charge drops below 10%, the ET5X displays a notice to connect the ET5X to power. The user must charge the battery using one of the charging accessories.

When the battery charge drops below 4%, the ET5X turns off. Place the ET5X into a cradle to charge the battery.

Battery Optimization

Observe the following battery saving tips:

- Set the screen to turn off after a short period of non-use. See [Setting Screen Timeout Setting on page 28](#).
- Reduce screen brightness. See [Setting the Screen Brightness on page 28](#).
- Turn off all wireless radios when not in use.
- Turn off automatic syncing for Email, Calendar, Contacts and other applications.
- Use the Power Control widget to check and control the status of radios, the screen brightness, and syncing.
- Minimize use of applications that keep the ET5X from suspending, for example, music and video applications.



Turning Off the Radios

To turn off all the radios:

1. Press the power button until the menu appears and touch **Airplane mode**.
or, swipe down from the status bar and touch **Airplane mode**.
2. The airplane icon  appears in the Status bar indicating that all the radios are off.

Setting the Date and Time

The date and time is automatically synchronized using a NITZ server when the ET5X is connected to a Wi-Fi network. To manually change the date and time:

1. Swipe down with two fingers from the status bar to open the quick access panel and then touch .
2. Touch  **Date & time**.
3. Touch **Automatic date & time** to disable automatic date and time synchronization.
4. Touch **Set date**.
5. Touch < and > to select month.
6. Touch day.
7. Touch **OK**.
8. Touch **Set time**.
9. Touch and rotate the green circle to the current hour and then release.
10. Touch and rotate the green circle to the current minute and then release.
11. Touch **AM** or **PM**.
12. Touch **OK**.
13. Touch **Automatic time zone** to disable automatic time zone synchronization.
14. Touch **Select time zone**.
15. Select the current time zone from the list.
16. Touch .

Display Setting

Use Display settings to change the screen brightness, set sleep time and change font size.

Setting the Screen Brightness

To manually set the screen brightness:







1. Swipe down with two fingers from the status bar to open the quick access panel and then touch .
2. Touch  **Display**.
3. Touch **Brightness level**.

Figure 20 Brightness Dialog Box





4. Use the slider to set a brightness level.
5. Touch .

To automatically set the screen brightness:

1. Swipe down with two fingers from the status bar to open the quick access panel and then touch .
2. Touch  **Display**.
3. Touch **Adaptive brightness**. The control switch moves to the right and turns green indicating the option is enabled.
4. Touch .



Setting Screen Timeout Setting

To set the screen sleep time:

1. Swipe down with two fingers from the status bar to open the quick access panel and then touch .
2. Touch  **Display** > **Sleep**.
3. Select one of the sleep values.
 - **15 seconds**
 - **30 seconds**
 - **1 minute** (default)
 - **2 minutes**
 - **5 minutes**
 - **10 minutes**
 - **30 minutes**.
4. Touch .

Setting Font Size

To set the size of the font in system applications:

1. Swipe down with two fingers from the status bar to open the quick access panel and then touch .
2. Touch  **Display > Font size**.
3. Select one of the font size values.
 - Small
 - **Normal** (default)
 - **Large**
 - **Huge**.
4. Touch .

Setting Screen Rotation



NOTE By default, screen rotation is disabled. See [Device Sensors on page 24](#) to turn on the sensors.

After enabling the sensors, screen rotation is enabled and stay enabled until user performs an Enterprise Rest.

To lock the screen in portrait or landscape mode:



1. Rotate the screen to the desired orientation.
2. Touch  **Display > When device is rotated > Stay in current orientation**.

or



Swipe down with two fingers from the status bar to open the quick access panel and touch the Auto-rotate  icon.

3. Touch .

To re-enable screen rotation:

1. Swipe down with two fingers from the status bar to open the quick access panel and then touch .
2. Touch  **Display > When device is rotated > Rotate the contents of the screen**.

or

Swipe down with two fingers from the status bar to open the quick access panel and touch the Landscape  or Portrait  icon.

3. Touch .

Touch Mode

The ET5X display is able to detect touches using a finger, a conductive-tip stylus or gloved finger.



1. Swipe down with two fingers from the status bar to open the quick access panel and then touch .
2. Touch  **Display > Touch mode**.

Figure 21 Touch Mode



3. Select one of the following options:

- touch **Finger and Thin Glove** to use a finger or a thin gloved finger on the screen
- touch **Stylus, Glove and Finger (Rain mode)** to use a stylus, gloved finger or a finger on the screen and when water droplets might be on the screen
- touch **Finger only** to use a finger on the screen.

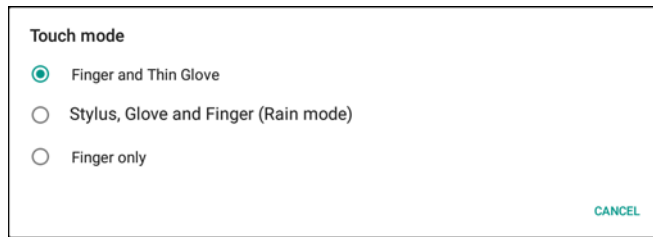

IMPORTANT: Screen touch is disabled for 15 seconds while configuring touch mode.

General Sound Setting

Use the **Sounds & notifications** settings to configure media and alarm volumes.



1. Swipe down with two fingers from the status bar to open the quick access panel and then touch .
2. Touch  **Sounds and Notifications**.

Figure 22 Sounds Screen



Sound

- **Media volume** - Controls the music, games and media volume.
- **Alarm volume** - Controls the alarm clock volume.
- **Notification volume** - Controls the system notification volume.
- **Do not disturb** - Mutes the ET5X so that it does not make sounds or vibrate when you do not want it to.
 - **Priority only allows** - Use to set priorities.
 - **Alarms**: Disabled
 - **Reminders** and **Events**: Switch on or off.
 - **Messages** and **Calls**: Choose from anyone, starred contacts, any contact, or none. To star contacts, use the **Contacts** app.

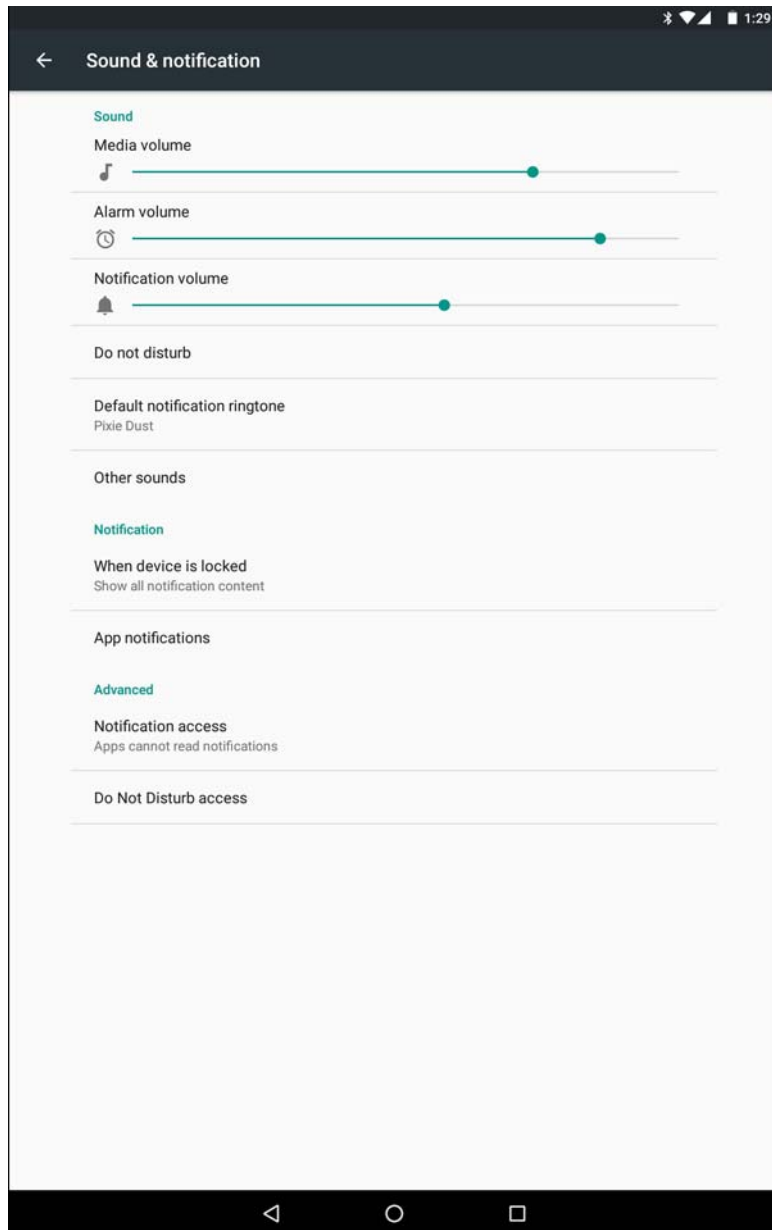
- **Repeat callers:** Choose whether to let the ET5X ring if the same person calls again within 15 minutes.
- **Automatic rules** - To automatically silence the ET5X during certain times, like at night or on weekends. Touch a default rule **Weekend** or **Weeknight**. Or, to make your own rule, tap **Add rule** and then **Time rule** or **Event rule**.
- **Default notification ringtone** - Touch to select a sound to play for all system notifications.
- **Other sounds**
 - **Screen locking sounds** - plays a sound when locking and unlocking the screen (default – enabled)
 - **Charging sounds** - Not applicable (default – disabled)
 - **Touch sounds** - Plays a sound when making screen selections (default – enabled).
 - **Vibrate on touch** - Vibrates when making screen selections (default – enabled).

Notification

- **When device is locked** - Manage whether notifications can be seen when the ET5X is locked. Options: **Show all notification content** (default) or **Don't show notifications at all**.
- **App notification** - Modify the notification settings individually for an application. The setting under **When device is locked** always takes precedence over the setting for an individual application.

Advanced

- **Notification access** - Displays which applications can access notifications.
When a notification arrives, its icon appears at the top of the screen. Icons for pending notifications appear on the left, and system icons on the right.
- **Do Not Disturb access** - Displays which applications can access Do Not Disturb feature.

Do Not Disturb Feature

This mode mutes the ET5X so that it does not make sounds or vibrate.

For example, use Do Not Disturb to:

- Automatically limit sounds at night or during events
- Mute interruptions other than alarms
- Get alerted to messages only from favorite contacts.

Limit Sounds and Vibrations

Mute the ET5X completely, or let through the important alarms or important calls.

Total Silence

To completely mute the ET5X so that it does not make a sound or vibrate, choose **Total silence**.

In Total silence mode:

- Alarms do not make noise.
- ET5X does not vibrate or make sounds when receiving a message, or notification.
- Sounds from music, videos, games, and other media are muted.



NOTE: The user will not hear alarms in Total silence mode.

1. Swipe down with two fingers from the status bar to open the quick access panel.
2. Touch **Do not disturb > Total silence**.
3. Choose **Until you turn it off** or select a time period.
4. Touch **Done**.

When Total Silence is on,  appears in the quick access panel and the Status Bar.

To turn off Total Silence, open quick access panel and touch **Total silence**.

Alarms Only

To mute the ET5X so that the user hears alarms, choose **Alarms only**. This option does not mute sounds from music, videos, games, or other media.

1. Swipe down with two fingers from the status bar to open the quick access panel.
2. Touch **Do not disturb > Alarms only**.
3. Choose **Until you turn it off** or select a time period.
4. Tap **Done**.

When Alarms Only is on,  appears in the quick access panel and the Status Bar.

To turn off Alarms Only, open quick access panel and touch **Alarms only**.





NOTE: To quickly turn on Alarms Only, with the screen on, press and hold the Volume Down button until the volume is all the way down. Then, press Volume Down again to turn on Alarms Only.

To turn off Alarms Only, press either the Volume Up or Volume Down button and the touch **END NOW** in the alert message. Then, press Volume Up again to turn on Alarms Only.

Priority Notifications Only

To only be interrupted by important notifications, choose Priority Only. This option does not mute sounds from music, videos, games, or other media.

Before turning on Priority Only mode, set the notification priorities:

1. Swipe down with two fingers from the status bar to open the quick access panel and then touch .
2. Touch  **Sounds and notifications > Do not disturb > Priority only allows**.
3. Set priorities.
 - **Alarms:** Disabled by default.
 - **Reminders and Events:** Switch on or off.
 - **Messages and Calls:** Choose **From anyone**, **From contacts only**, **From starred contacts only**, or **none**. To star contacts, use the **Contacts** app.
 - **Repeat callers:** Choose whether to let the ET5X ring if the same person calls again within 15 minutes.

After setting notification priorities, turn on Priority only mode to limit interruptions. The priority notifications make a sound or vibrate based on the current ringer volume, but other notifications will be silenced.

1. Swipe down with two fingers from the status bar to open the quick access panel.

2. Touch **Do not disturb > Priority only**.
3. Choose **Until you turn it off** or select a time period.
4. Tap **Done**.



When Priority Only is on,  appears in the quick access panel and the Status Bar.

To turn off Priority Only, open quick access panel and touch **Priority only**.

Automatically Block Sounds and Vibrations



Silence Sounds During Certain Times

To automatically silence the ET5X during certain times, like at night or on weekends, set the time rules.



1. Swipe down with two fingers from the status bar to open the quick access panel and then touch .
2. Touch  **Sound & notification > Do not disturb > Automatic rules**.
3. Touch a default **Weekend** or **Weeknight**. Or, to make a new rule, touch **Add rule** and then **Time rule**.
4. Edit the new rule:
 - **Rule name**: Name the rule.
 - **Days, Start time, and End time**: Set the rule's schedule.
 - **Do not disturb**: Choose whether the rule uses **Alarms only**, **Priority only**, or **Total silence**.
5. Touch the On/Off text or switch at the top to turn on the rule.

Silence Sounds During Events and Meetings

To automatically silence the ET5X during events or meetings, set an event rules.

1. Swipe down with two fingers from the status bar to open the quick access panel and then touch .
2. Touch  **Sound & notification > Do not disturb > Automatic rules**.
3. To edit the default rule, touch **Event**. Or, to create a new rule, touch **Add rule > Event rule**.
4. Edit the rule settings.
 - **During events for**: Select which Google Calendar events the rule uses.
 - **Where reply is**: Options: **Yes, Maybe, or Not replied, Yes or Maybe, or Yes**.
 - **Do not disturb**: Choose whether the rule uses **Priority only**, **Alarms only**, or **Total silence**.
5. Touch the On/Off switch at the top to turn on the rule.

Turn Sounds Back On

When the ET5X is in Do Not Disturb mode, Alarms or Priority only  or Total silence  display.

To turn off Do Not Disturb, either:

- In the quick access panel, touch **Alarms only**, **Priority only**, or **Total silence**.
- Press the Volume Down button and touch **End Now**.

Override Do Not Disturb for Specific Apps

To let through notifications from specific apps:

1. Open **Settings > Sounds & Notifications > App notifications**.

2. Touch an app.
3. Touch **Treat as Priority**. This lets notifications through Priority only mode but not Total silence or Alarms only.

Using the Tablet

Introduction

This chapter describes the screens, status and notification icons, and controls on the ET5X, and provides basic instructions for using the ET5X.

Google Mobile Services



NOTE This section only applies to ET5X configurations with Google Mobile Services (GMS).

The ET5X with GMS contains applications and services that provide additional functionality to the ET5X.

GMS includes:

- **Applications** - GMS adds a variety of Google applications and associated widgets including Chrome, Gmail, Drive and Maps.
- **Services:**
 - **Speech to Text** - Allows for free format speech to text, in many languages for both connected and disconnected network. Launch by touching the microphone icon on the keyboard.
 - **TalkBack Service** - Provides spoken feedback on various parts of the user interface. To enable, go to **Settings > Accessibility**.
 - **Network Location Provider** - Adds a location provider which uses mobile network tower information and Wi-Fi access point information to provide a location without using GPS. To enable, go to **Settings > Location access**.
 - **Widevine DRM** - Enables the digital rights management so that protected content can be played. Enable via DRM Info from the Play Store.
 - **Google Cloud Messaging** - Allows the sending of data from your server to your ET5X and also to receive messages from devices on the same connection.
 - **Backup and Restore** - Allows the users settings and applications to be backed up to a Google server and subsequently restored from that server after a factory reset.

Home Screen

The Home screen displays when the ET5X turns on. Depending upon the configuration, the Home screen might appear different. Contact your system administrator for more information.

After a suspend or screen time-out, the Lock screen displays. Slide up to unlock the screen if no security is set. For screen locking information see [Un-Locking the Screen on page 49](#).



NOTE By default, non-GMS devices do not have icons on the Home screen. Icons are shown below for example only.

Figure 23 Home Screen (non-GMS)

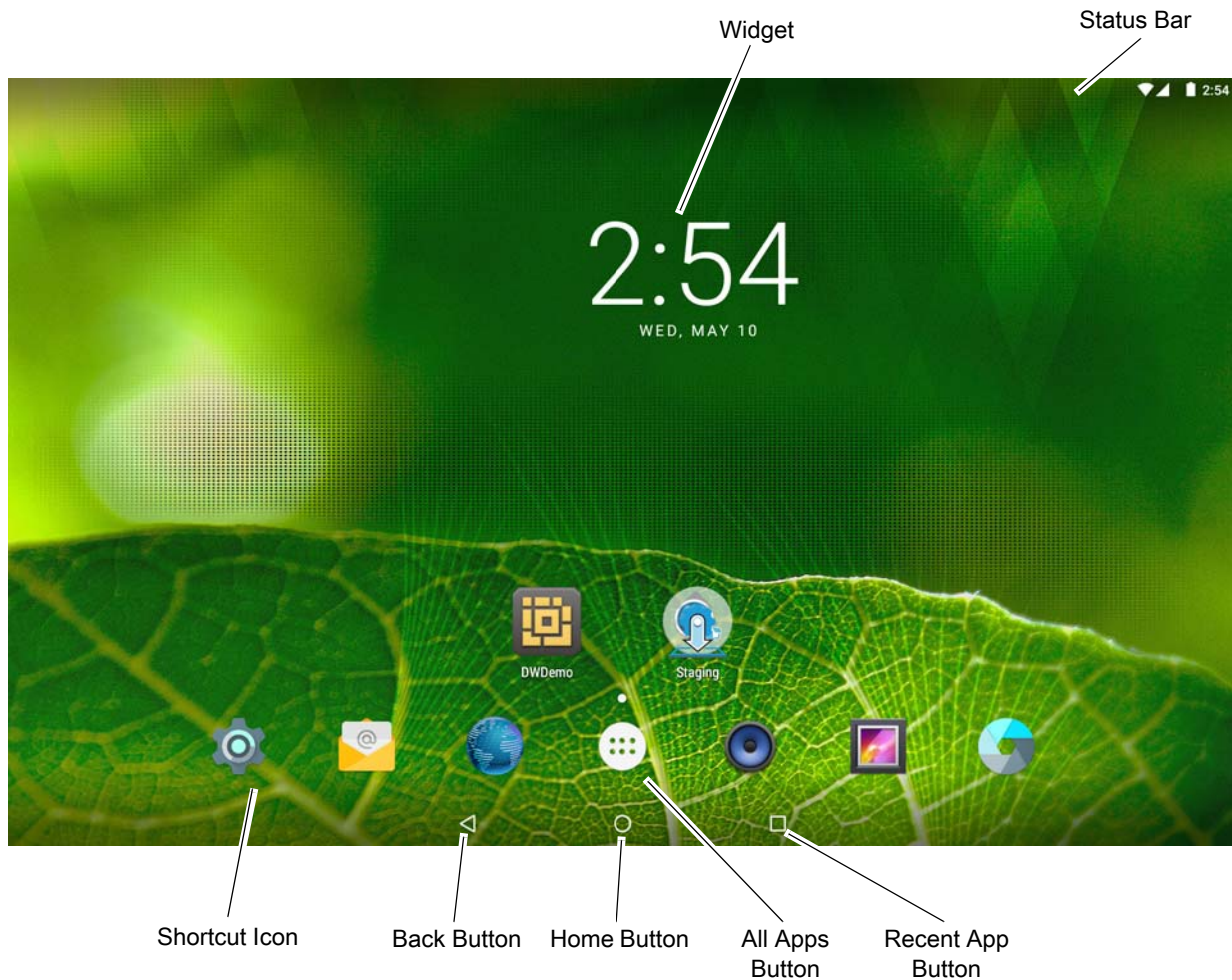
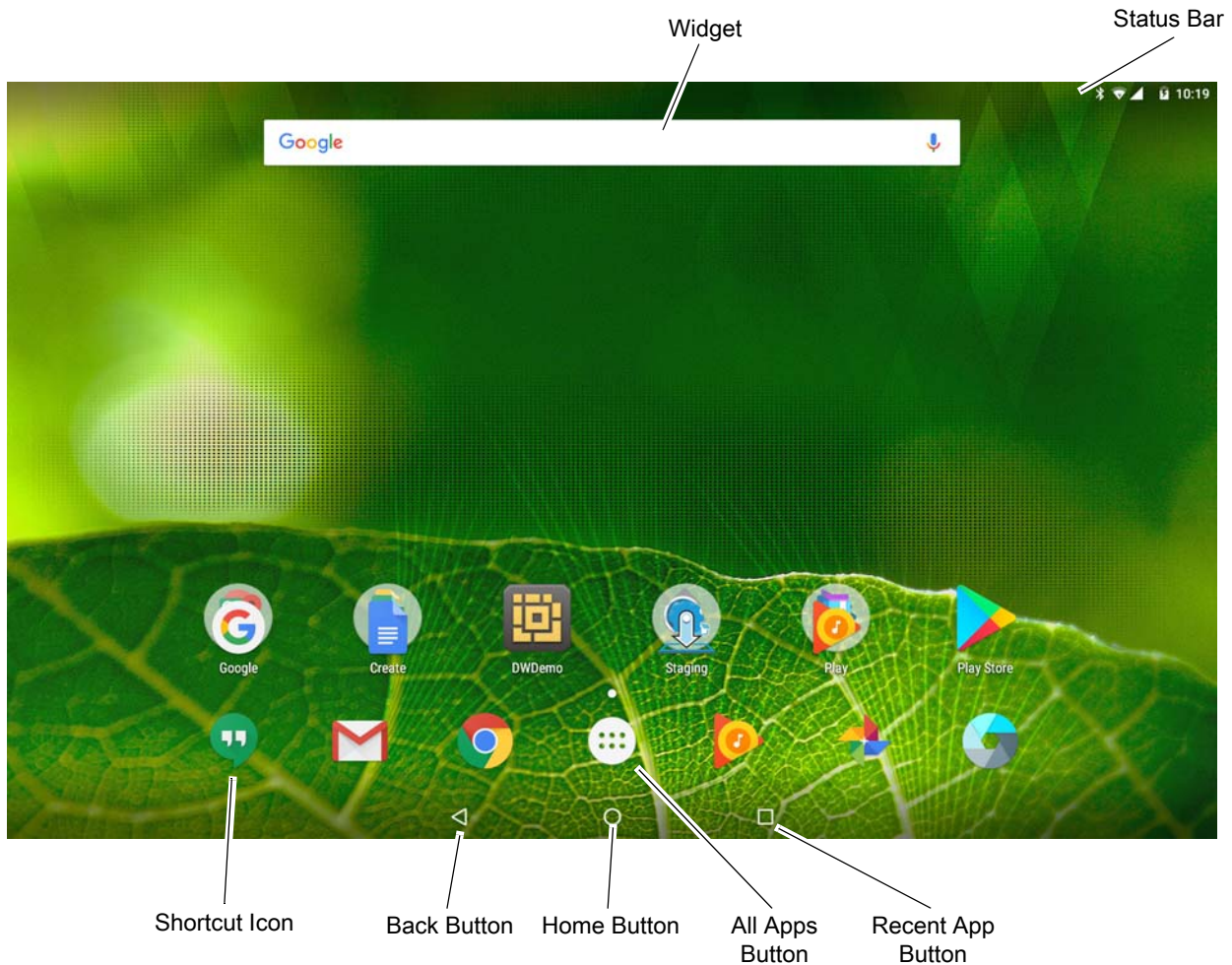

Figure 24 Home Screen (GMS)



NOTE The Home screen icons can be configured by the user and may look different than shown.

The Home screen provides four additional screens for placement of widgets and shortcuts. Swipe the screen left or right to view the additional screens.

Status Bar

The Status bar displays the time, notification icons (left side) and status icons (right side).

If there are more notifications than can fit in the Status bar, displays indicating that more notifications exist. Open the Notifications panel to view all notifications and status.

Status Icons

Table 6 Status Icons







































Icon	Description
	Indicates that the Alarm is active.
	Indicates that the ringer is silenced.
	Indicates that the main battery is fully charged.
	Indicates that the main battery is partially drained.
	Indicates that the main battery charge is low.
	Indicates that the main battery charge is very low.
	Indicates that the main battery is charging.
	Indicates that the optional Power Pack is fully charged.
	Indicates that the optional Power Pack is partially drained.
	Indicates that the optional Power Pack charge is low.
	Indicates that the optional Power Pack charge is very low.
	Indicates that the optional Power Pack is charging when in charging cradle.
	Indicates that the Airplane Mode is active. All radios are turned off.
	Indicates that Bluetooth is on.
	Indicates the ET5X is connected to a Wi-Fi network.
	Indicates that the ET5X is not connected to a Wi-Fi network or no Wi-Fi signal.
	Indicates that the ET5X is connected to an Ethernet network.
	Indicates that a Headset is connected to the ET5X.

Table 6 Status Icons (Continued)

Icon	Description
	Indicates that Do Not Disturb Alarm only or Priority only mode is enabled.
	Indicates that Do Not Disturb Total Silence mode is enabled.

Notification Icons

Table 7 Notification Icons

Icon	Description
	Indicates the main battery is low.
	Indicates that more notifications are available for viewing.
	Indicates that data is syncing.
	Indicates an upcoming event.
	Indicates that an open Wi-Fi network is available.
	Indicates that a song is playing. (ET5X without GMS)
	Indicates that a song is playing. (ET5X with GMS)
	Indicates that a problem with sign-in or sync has occurred.
	Indicates that the ET5X is uploading data.
	Indicates that the ET5X is downloading data when animated and download is complete when static.
	Indicates that the ET5X is connected via USB cable.
	Indicates that the ET5X is connected to or disconnected from virtual private network (VPN).
	Preparing Internal Storage.
	Indicates that USB debugging is enabled on the ET5X.
	Indicates that a Expansion Pack is installed and in HID Mode.
	Indicates that the RxLogger application is running and capturing data.
	Indicates that the RS507 is connected to the ET5X.
	Indicates that user attention is required.

Managing Notifications

Notification icons report the arrival of new messages, calendar events, and alarms, as well as ongoing events. When a notification occurs, an icon may appear in the Status bar with a brief description. See [Notification Icons on page 40](#) for a list of possible notification icons and their description. Open the Notifications panel to view a list of all the notifications.

To open the Notification panel, drag the Status bar down from the top of the screen.

Figure 25 Notification Panel

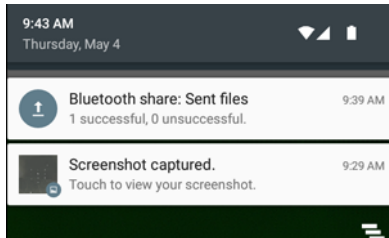

To respond to a notification, open the Notifications Panel and then touch a notification. The Notifications Panel closes and the subsequent activity is dependent on the notification.

To clear all notifications, open the Notifications Panel and then touch . All event-based notifications are removed.

Ongoing notifications remain in the list.

To close the Notification Panel, swipe the Notifications Panel up.

Quick Settings

Use Quick Access Panel to get to frequently used settings, like turning on airplane mode. To open Quick Access Panel, swipe down from the top of the screen with two fingers or twice with one finger.

Figure 26 Quick Settings

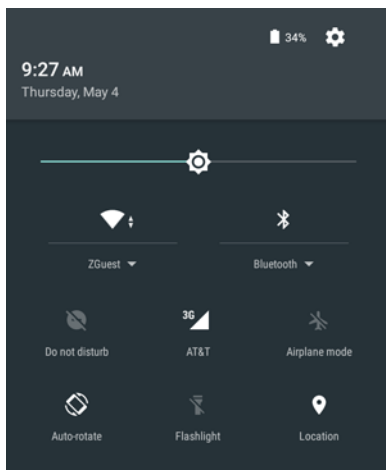

To change a setting, just touch the icon:

- Display brightness: Slide to lower or increase the brightness of the screen.
- Wi-Fi network: Turn Wi-Fi on or off. To open Wi-Fi settings, touch the Wi-Fi network name.
- Bluetooth settings: Turn Bluetooth on or off. To open Bluetooth settings, touch the **Bluetooth**.

- Do not disturb: Control how and when to receive notifications.
- Cellular settings: Turns Cellular radio on or off. To open Cellular settings, touch to view cellular data usage.
- Airplane mode: Turn airplane mode on or off. Airplane mode means device will not connect to Wi-Fi or Bluetooth.
- Auto-rotate: Lock the device's orientation in portrait or landscape mode or set to automatically rotate.
- Flashlight: Turn camera flash on and off.
- Location: Enable or disable locationing feature.

Application Shortcuts and Widgets

Application shortcuts placed on the Home screen allow quick and easy access to applications. Widgets are self-contained applications placed on the Home screen to access frequently used features.

Adding an Application or Widget to the Home Screen

1. Go to the desired Home screen.
2. Touch .
3. Swipe right, if necessary, to find the application icon or widget.
4. Touch and hold the icon or widget until the Home screen appears.
5. Position the icon on the screen and then release.

Moving Items on the Home Screen

1. Touch and hold the item until it floats on the screen.
2. Drag the item to a new location. Pause at the edge of the screen to drag the item onto an adjacent Home screen.
3. Lift finger to place the item on the Home screen.

Removing an App or Widget from the Home Screen

1. Go to the desired Home screen.
2. Touch and hold the application shortcut or widget icon until it floats on the screen.
3. Drag the icon to  Remove on the top of the screen and then release.

Folders

Use Folders to organize similar applications together. Tap the folder to open and display items in the folder.

Using the Touchscreen

Use the multi-tap sensitive screen to operate the device.

- **Tap** - Tap to:
 - select items on the screen
 - type letters and symbols using the on-screen keyboard
 - press on-screen buttons.

- **Tap and Hold** - Tap and hold:
 - an item on the Home screen to move it to a new location or to the trash.
 - an item in Apps to create a shortcut on the Home screen.
 - the Home screen to open a menu for customizing the Home screen.
 - an empty area on the Home screen until the menu appears.
- **Drag** - Tap and hold an item for a moment and then move finger on the screen until reaching the new position.
- **Swipe** - Move finger up and down or left and right on the screen to:
 - unlock the screen
 - view additional Home screens
 - view additional application icons in the Launcher window
 - view more information on an application's screen.
- **Double-tap** - Tap twice on a web page, map, or other screen to zoom in and out.
- **Pinch** - In some applications, zoom in and out by placing two fingers on the screen and pinching them together (to zoom out) or spreading them apart (to zoom in).

Using the On-screen Keyboard

Use the on-screen keyboard to enter text in a text field. To configure the keyboard settings, touch and hold the comma key and select  and then select **Android Keyboard Settings**.

Figure 27 On-screen Keyboard



Editing Text

Edit entered text and use menu commands to cut, copy, and paste text within or across applications. Some applications do not support editing some or all of the text they display; others may offer their own way to select text.

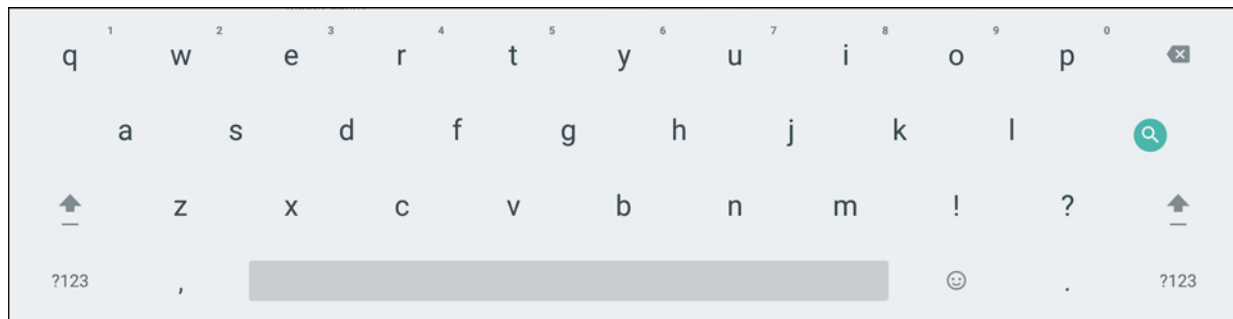
Entering Numbers, Symbols and Special Characters

To enter numbers and symbols:

- Touch and hold one of the top-row keys until a menu appears then select a number.
- Touch and hold the Shift key with one finger, touch one or more capital letters or symbols to enter them, and then lift both fingers to return to the lowercase keyboard.
- Touch the Shift key twice to lock capital letters. Touch the Shift key again to return to lowercase keyboard.
- Touch **?123** to switch to the numbers and symbols keyboard.

- Touch the \Rightarrow key on the numbers and symbols keyboard to view additional symbols.
- Touch 😊 key to switch to the emoji keyboard.

To enter special characters, touch and hold a number or symbol key to open a menu of additional symbols. A larger version of the key displays briefly over the keyboard.

Applications

The APPS screen displays icons for all installed applications. The table below lists the applications installed on the ET5X. Refer to the ET5X Integrator Guide for information on installing and uninstalling application.

Table 8 Applications









Icon	Description
	AppGallery - Provides links to utilities and demonstration applications that can be installed on the device.
	Bluetooth Pairing - Use to pair the RS507 Hans-free Imager with the ET5X by scanning a bar code.
	Browser - Use to access the Internet or intranet. ET5X without GMS only.
	Calculator - Provides the basic and scientific arithmetic functions.
	Calendar - Use to manage events and appointments. ET5X with GMS only.
	Calendar - Use to manage events and appointments. ET5X without GMS only.
	Camera - Use to take photos and record videos.
	Chrome - Use to access the Internet or intranet. ET5X with GMS only.
	Clock - Use to schedule alarms for appointments or as a wake-up.

Table 8 Applications (Continued)

























Icon	Description
	Contacts - Use to manage contact information.
	DataWedge - Enables data capture using the imager.
	Diagnostic Tool - Use to diagnose the ET5X. See Diagnostic Tool on page 135 for more information.
	Docs - Use to view and write documents. ET5X with GMS only.
	Downloads - Lists all downloads files.
	Drive - Upload photos, videos, documents, and other files to personal storage site. ET5X with GMS only.
	DWDemo - Provides a way to demonstrate the data capture features using the imager. See DataWedge Demonstration on page 56 for more information.
	elemez - Use to provide diagnostic information. See Elemesz on page 75 for more information.
	ET5X User Guide - Displays the On-device User Guide.
	Email - Use to send and receive email. ET5X without GMS only.
	File Browser - Organize and manage files on the ET5X. See File Browser on page 54 for more information.
	Gmail - Use to send and receive email using a Google email account. ET5X with GMS only.
	Gallery - Use to view photos stored on the device. ET5X without GMS only.

Table 8 Applications (Continued)

Icon	Description
	Google - Launches Google search application. ET5X with GMS only.
	Google+ - Connect with people on Google social network. ET5X with GMS only.
	Hangouts - Use to communicate with friends using text messages and photos. ET5X with GMS only.
	Keep - Use to view and write notes. ET5X with GMS only.
	Maps - Use to see you location on a map (with public transit, traffic or satellite overlays). Search for any business or place of interest. Provides turn-by-turn navigation with voice guidance and traffic-avoidance and alternate routes, for drivers, cyclist, walkers and users of public transportation. ET5X with GMS only.
	Mobi Control Stage – Opens the Mobi Control Stage application to stage the device.
	Music - Play music stored on the device. ET5X without GMS only.
	Photos - Use to sync photos with Google account. ET5X with GMS only.
	Play Books - Use to read books. ET5X with GMS only.
	Play Movies & TV - View movies and video on your device. ET5X with GMS only.
	Play Music - Use to listen to music. ET5X with GMS only.
	Play Newsstand - Displays current news. ET5X with GMS only.
	Play Store - Download music, movies, books, and Android apps and games from the Google Play Store. ET5X with GMS only.

Table 8 Applications (Continued)

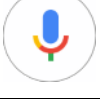
Icon	Description
	Rapid Deployment - Allows the ET5X to stage a device for initial use by initiating the deployment of settings, firmware and software. Requires the purchase of an MSP client license per device.
	RxLogger - Use to diagnose device and application issues. See the ET5X Integrator Guide for more information.
	Screen Blanking Settings - Use to enable screen blanking when using a Gambler Johnson cradle. See the ET5X Integrator Guide for Android™ 6.0.1 Marshmallow for more information. Available on BSP 02-14-30 and above.
	Search - Use the Google search engine to search the Internet and the ET5X. ET5X without GMS only.
	Settings - Use to configure the ET5X.
	Sheets - Use to view and create spreadsheets. ET5X with GMS only.
	Slides - Use to view and create presentations. ET5X with GMS only.
	Sound Recorder - Use to record audio.
	StageNow - Allows the ET5X to stage a device for initial use by initiating the deployment of settings, firmware and software.
	Voice Search - Use to perform searches by asking questions (Available only on devices with GMS software).
	YouTube - Use to view videos on the YouTube web site. ET5X with GMS only.

Accessing Applications

All applications installed on the device are accessed using the **APPS** window.

1. On the Home screen, touch .

Figure 28 APPS Window without GMS

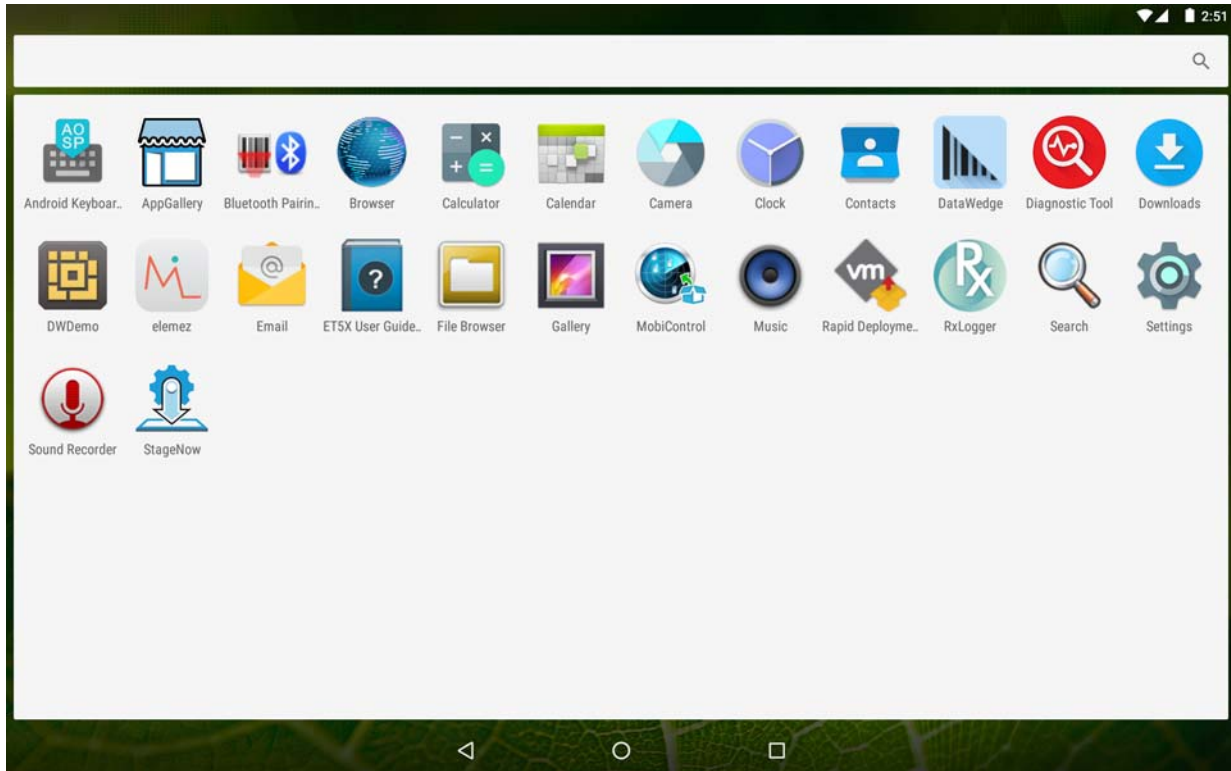
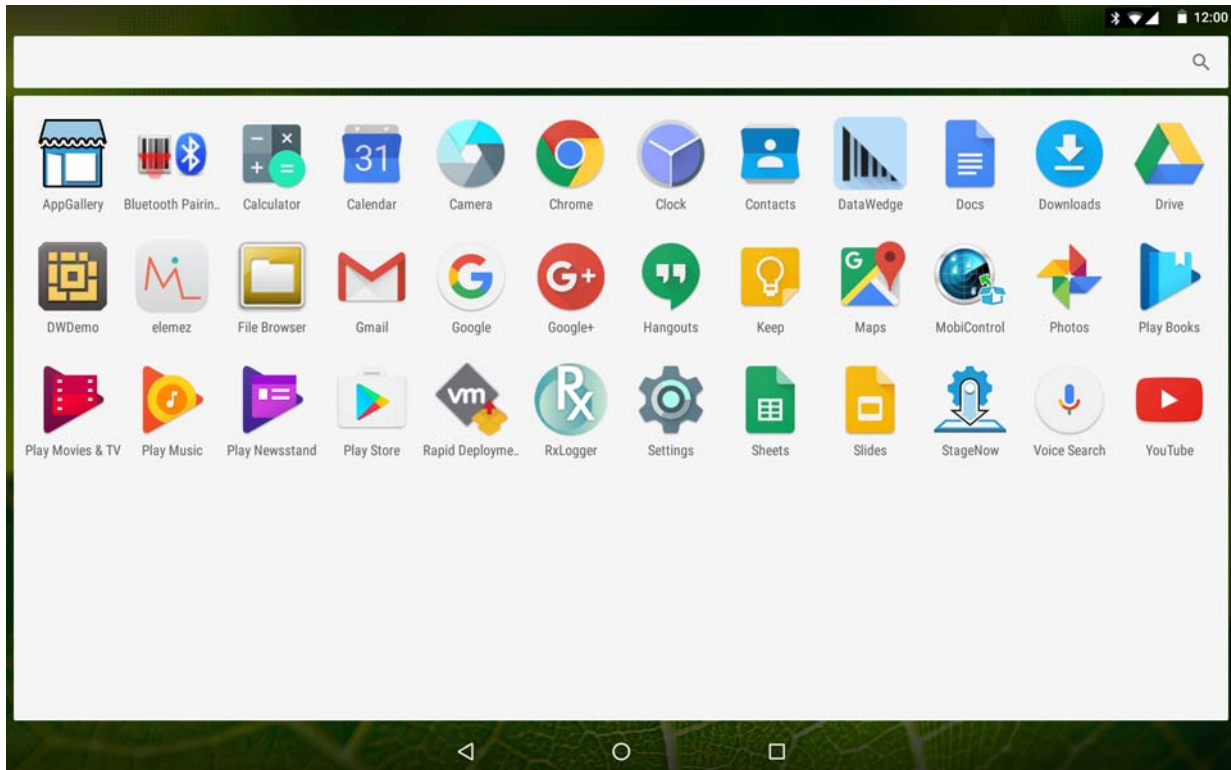

Figure 29 APPS Window with GMS



2. Slide the **APPS** window (left or right on ET5X without GMS or up and down on ET5X with GMS) to view more application icons. Touch an icon to open the application.

Switching Between Recent Applications



1. Touch . A window appears on the screen with icons of recently used applications.

Figure 30 Recently Used Applications

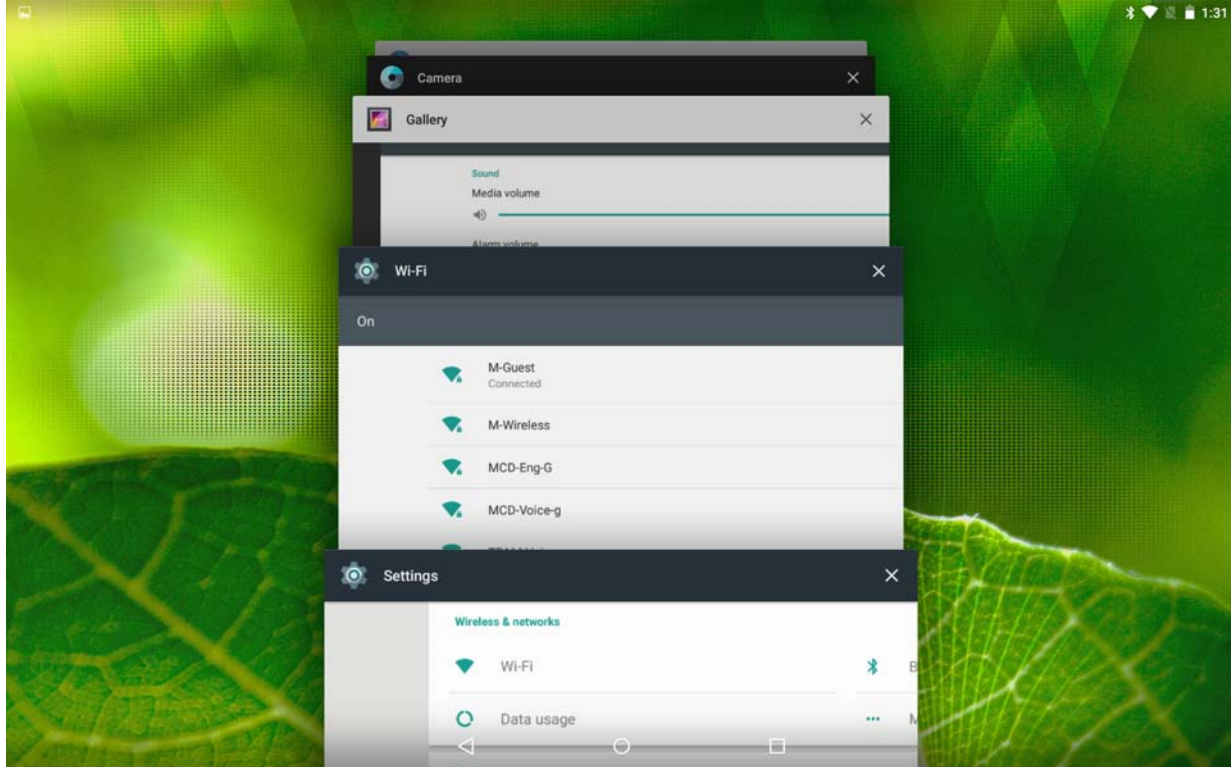

2. Slide the window up and down to view all recently used applications.
3. Swipe left or right to remove application from the list and force close the application.
4. Touch an icon to open it or touch  to return to the current screen.

Un-Locking the Screen

Use the Lock screen to protect access to data on the ET5X. Some email account require locking the screen. Refer to the ET5X Integrator Guide for information on setting up the locking feature.

When locked, a pattern, PIN or password is required to unlock the device. Press the Power button to lock the screen. The device also locks after a pre-defined time-out.

Press and release the Power button to wake the device. The Lock screen displays. Swipe up to unlock the screen.

If the PIN, Password or Pattern screen unlock feature is enabled, enter the PIN, password or pattern after unlocking the screen.

Figure 31 Lock Screen

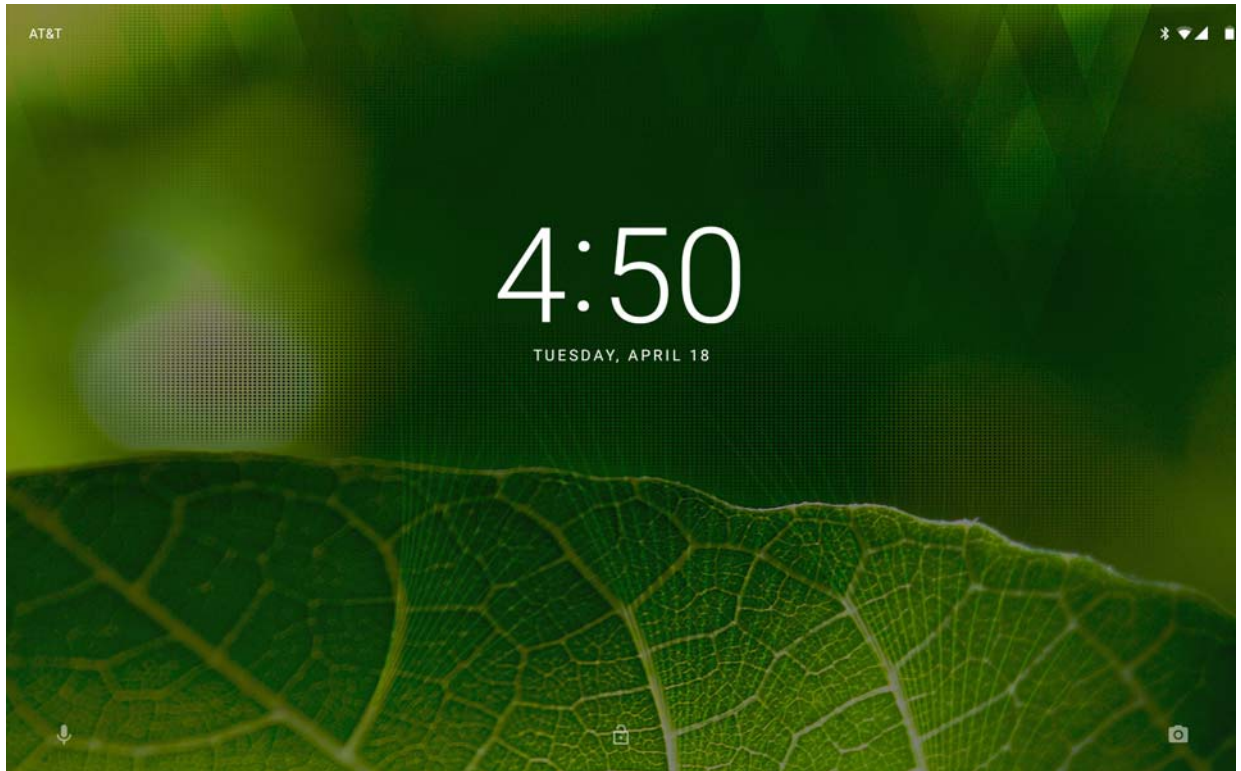

Figure 32 PIN Screen

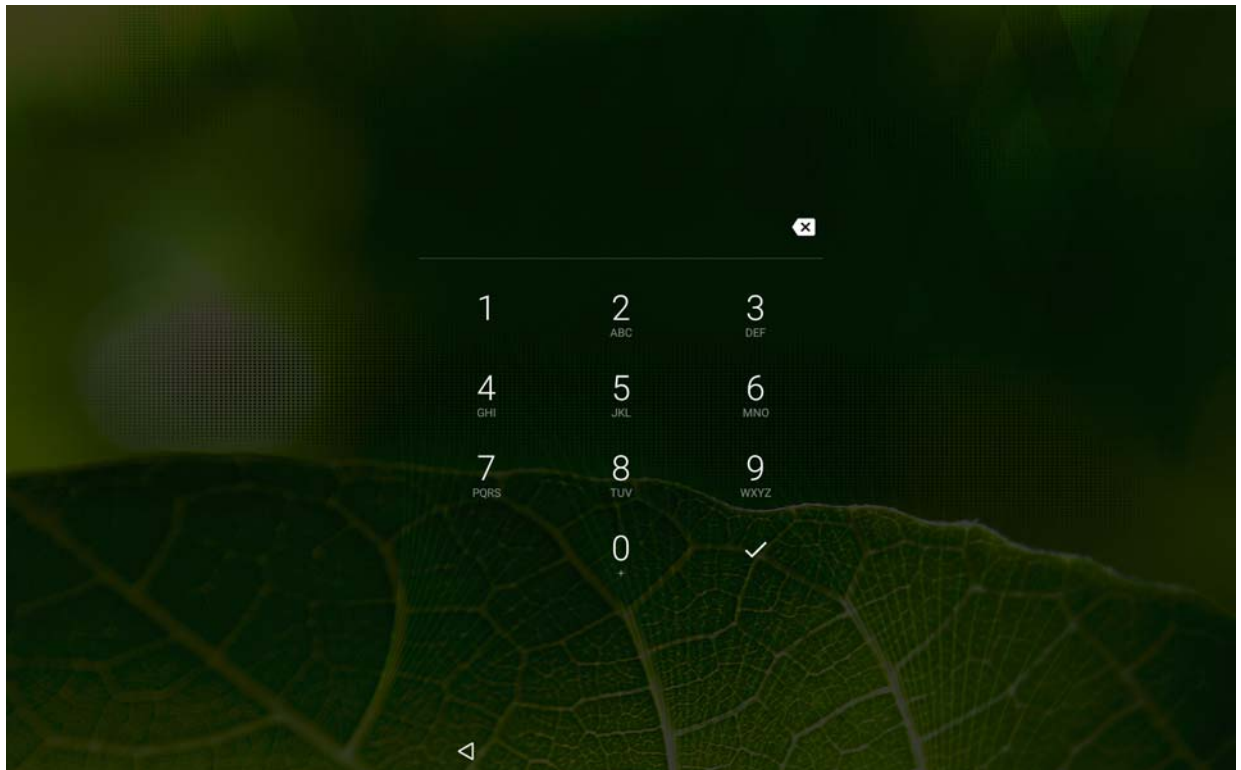

Figure 33 Pattern Screen

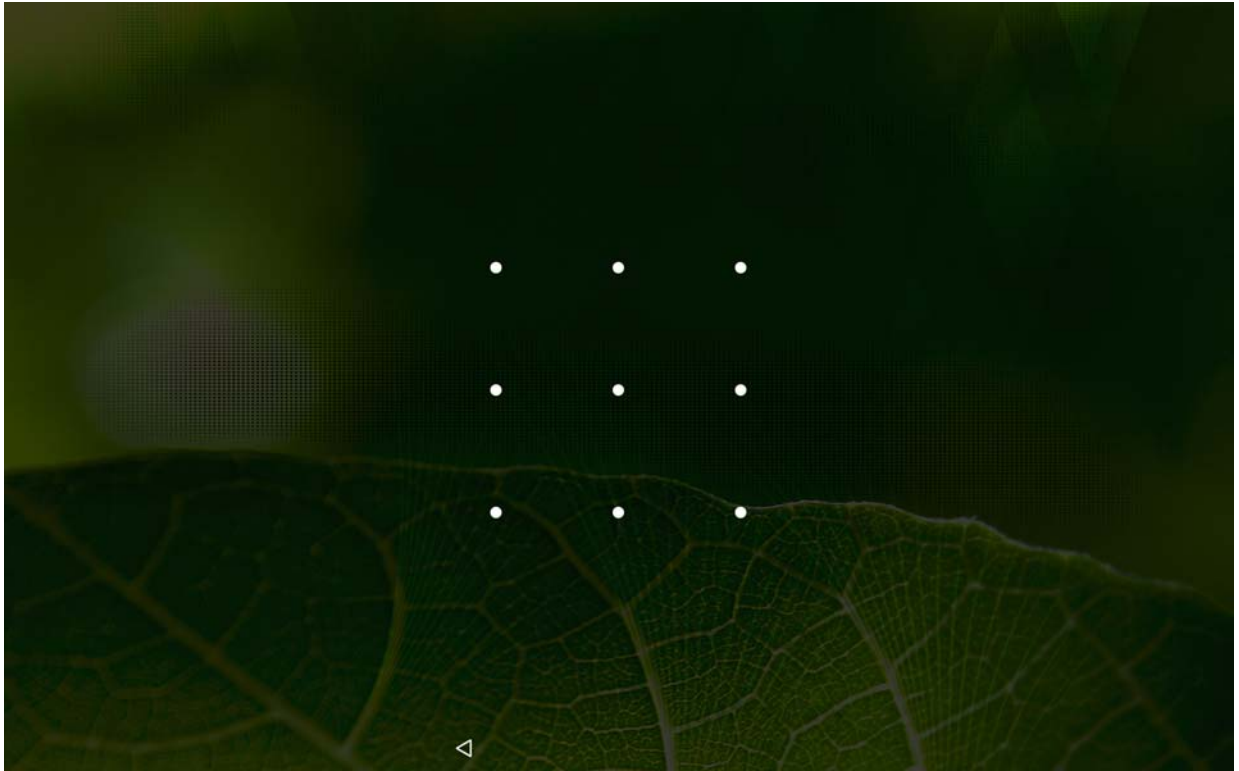
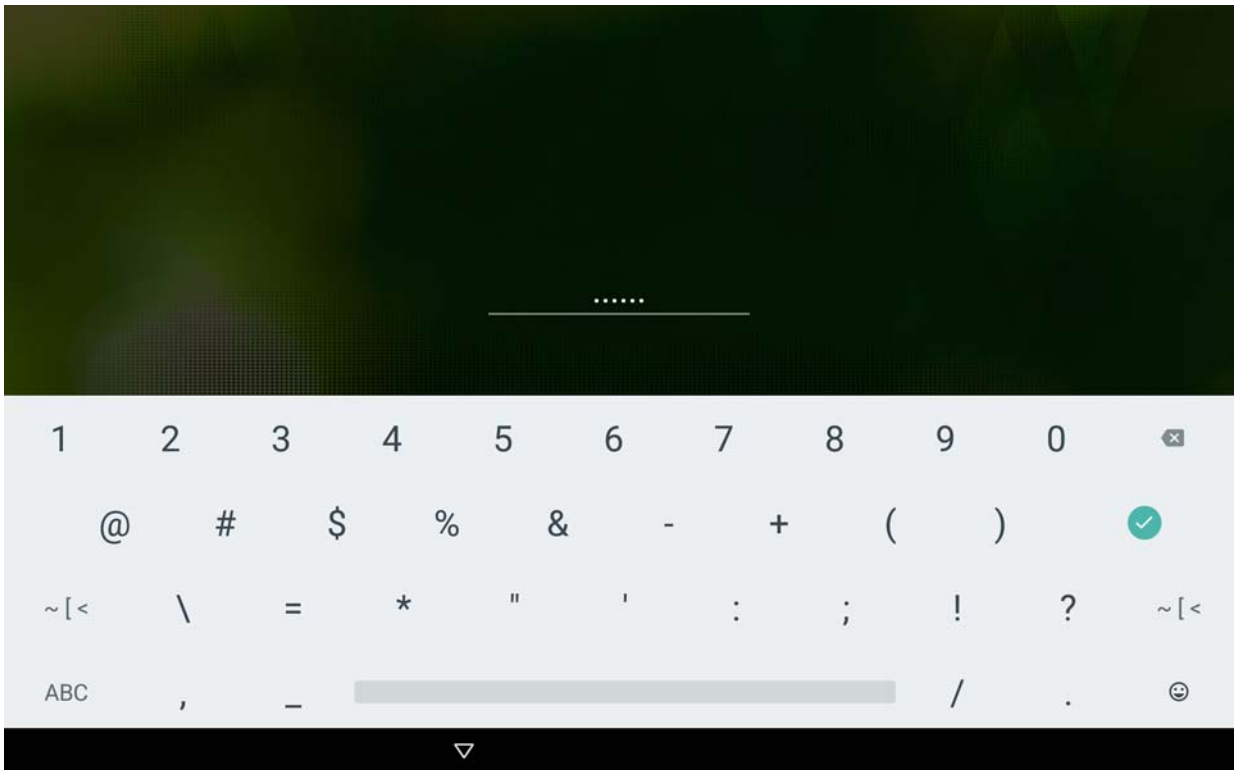

Figure 34 Password Screen



Suspend Mode

The ET5X goes into suspend mode when the user presses the Power button or after a period of inactivity (set in the Display settings).

To wake the ET5X from Suspend mode, press the Power button. The Lock screen displays. Swipe up to unlock the screen.



NOTE If the user enters the PIN, password or pattern incorrectly five times, they must wait 30 seconds before trying again.

If the user forgets the PIN, password or pattern contact the system administrator.

Figure 35 Lock Screen

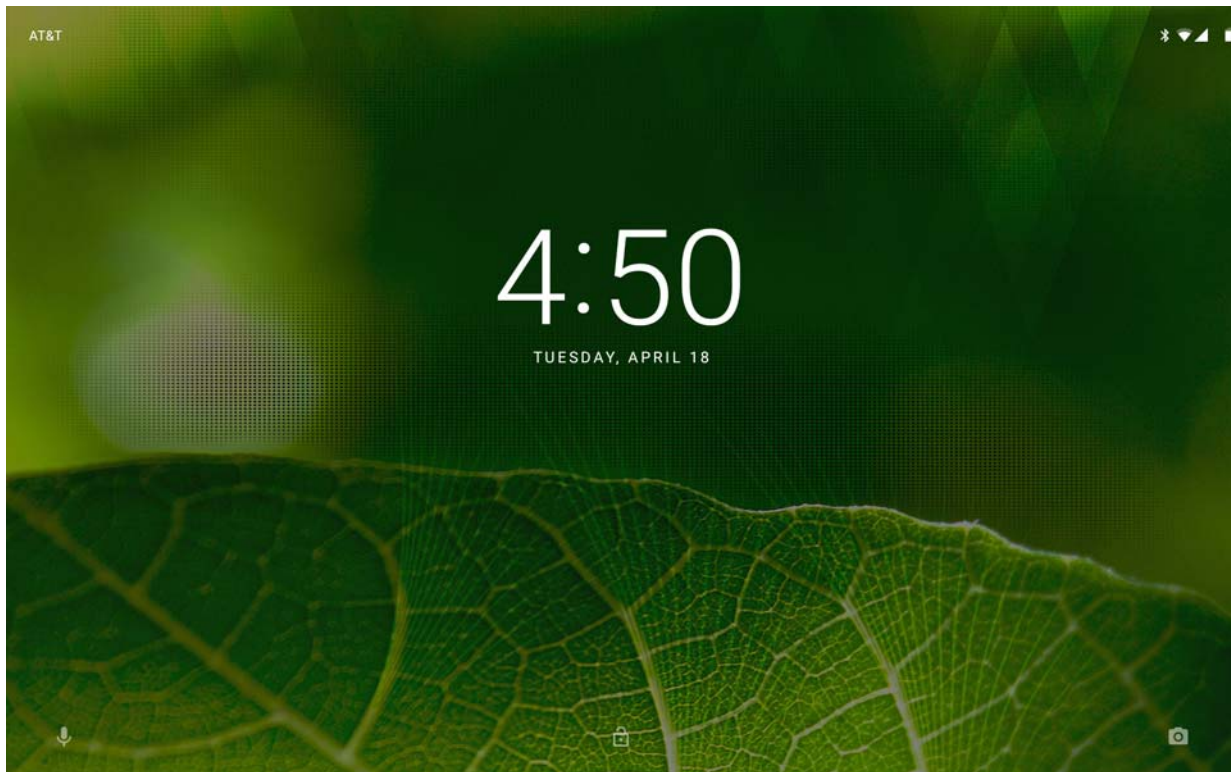

Rebooting the ET5X

There are two reset features on the ET5X; soft reset and hard reset.

Soft Reset

Reboot the device if applications stop responding.

1. Press the power button until the menu appears.
2. Touch **Reboot**.
3. The device reboots.

Hard Reset

If the ET5X is not responsive:



CAUTION Performing a hard reset with a SD card installed in the ET5X may cause damage or data corruption to the SD card.

All data is lost.

1. Press and hold the power button for at least 10 seconds. The ET5X shuts down.
2. Press the Power button to turn on the device.

Applications

Introduction

This chapter describes the applications installed on the device.

File Browser

Use the **File Browser** application to view and manage files on the device.

To open **File Browser**, touch  > .

Figure 36 File Browser Screen

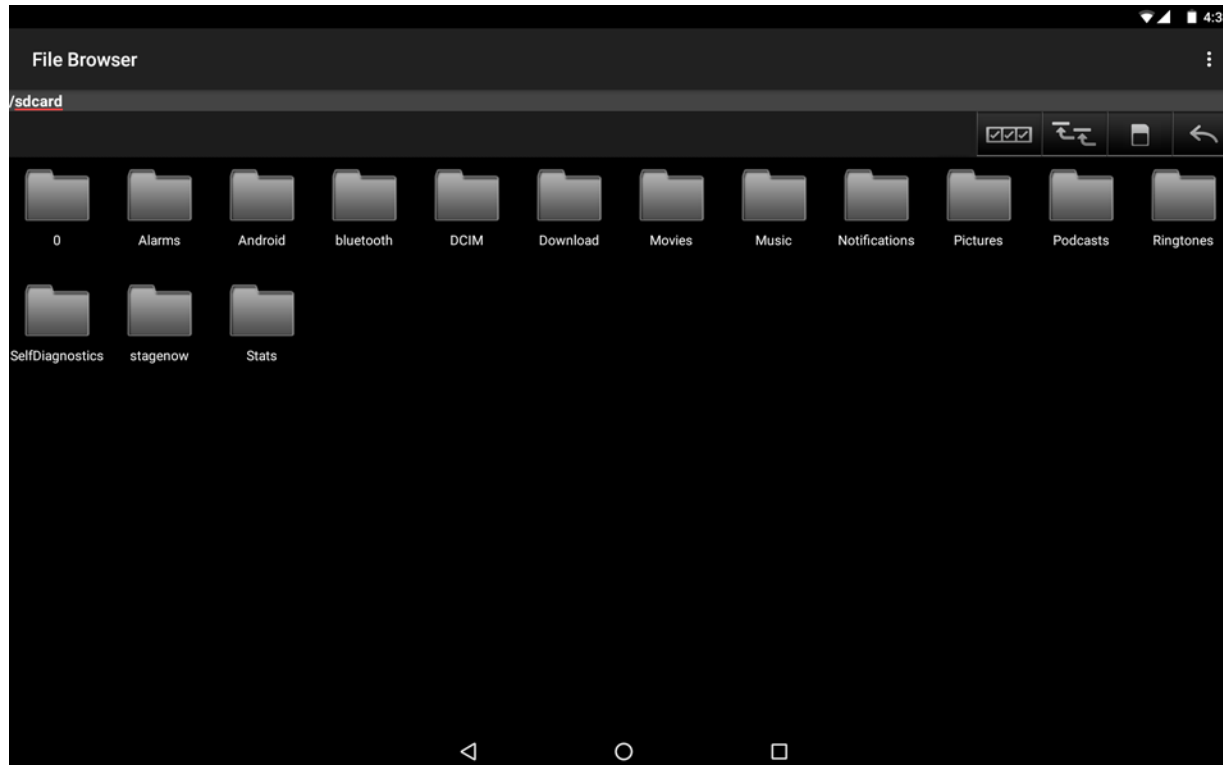

The address bar indicates the current folder path. Touch the current folder path to manually enter a path and folder name.

Use  to select multiple files/folder.

Use  to view the internal storage root folder.

Use  to view the microSD card root folder.

Use  to view the previous folder or to exit the application if at root folder.

Touch and hold an item to perform an operation on that item. Select one of the options from the **File Operations** menu:

- **Information** - View detailed information about the file or folder.
- **Move** - Move the file or folder to a new location.
- **Copy** - Copy the select file.
- **Delete** - Delete the selected file.
- **Rename** - Rename the select file.
- **Open as** - Open the selected file as a specific file type.
- **Share** - Share the file with other devices.

DataWedge Demonstration



NOTE DataWedge is enabled when on the Home screen displays. To disable this feature, go to the DataWedge settings and disable the **Launcher** profile.

The ET5X does not support data capture using the rear camera.

Use **DataWedge Demonstration** to demonstrate data capture functionality.

Figure 37 DataWedge Demonstration Window

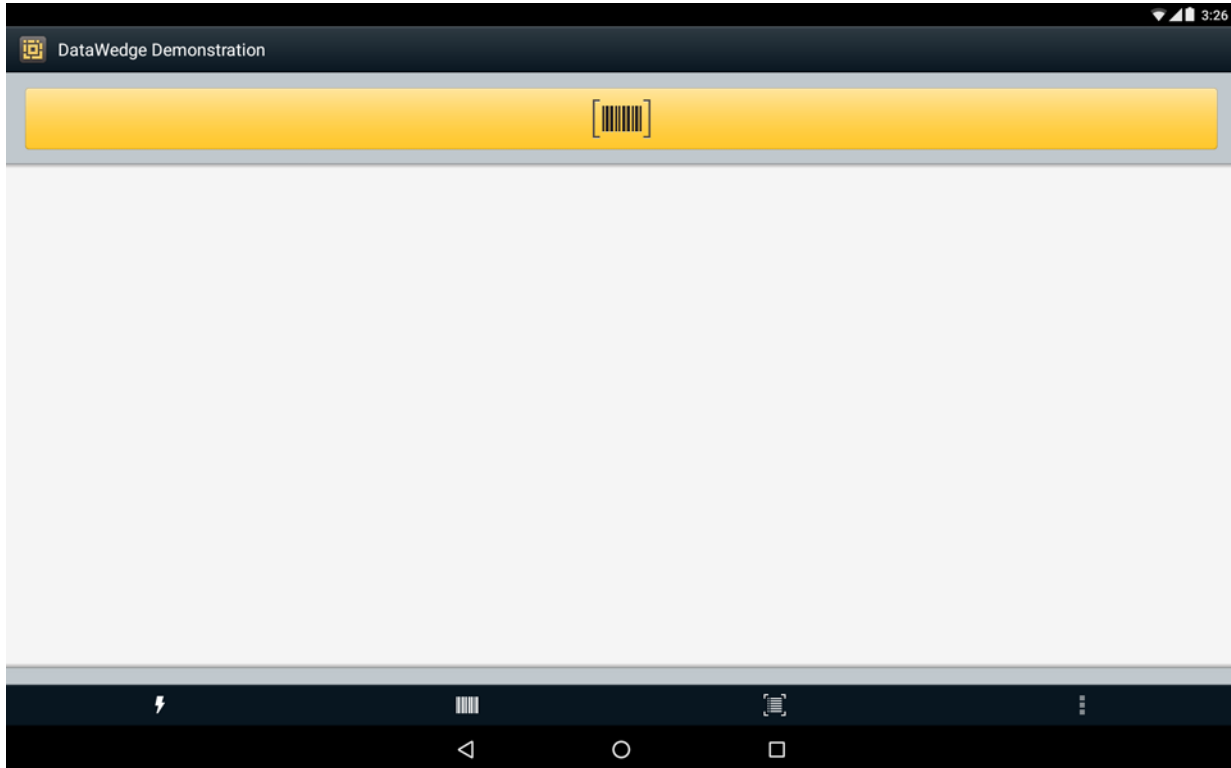









Touch the icons to select the available features.

Table 9 DataWedge Demonstration Icons

Feature	Icon	Description
Illumination		Indicates imager illumination is off. Touch to turn illumination on.
		Indicates imager illumination is on. Touch to turn illumination off.

Table 9 DataWedge Demonstration Icons (Continued)

Feature	Icon	Description
Data Capture		Indicates that the data capture function is through the Expansion Back imager.
		Indicates that a Bluetooth imager is not connected to the ET5X.
		Indicates that a Bluetooth imager is connected to the ET5X.
		Indicates that a USB scanner is connected to the ET5X.
		Indicates that a USB scanner is not connected to the ET5X.
Scan Mode		Indicates imager is in picklist mode. Touch to change to normal scan mode.
		Indicates imager is in normal scan mode. Touch to change to picklist mode.
Menu		Opens a menu to view the application information or to set the application DataWedge profile.



NOTE See the ET5X Integrator Guide for information on DataWedge configuration.

Press the Expansion Back Scan button or touch the yellow scan button to enable data capture. The captured data appears in the text field below the yellow button.

Camera

This section provides information for taking photos and recording videos using the integrated digital cameras.



NOTE When launching Camera app for the first time, the app requests access to device's location. Select **ALLOW** to allow the Camera app to access the tablet's location.

The ET5X saves photos and videos on the internal storage.

Taking Photos





1. Touch  > .
2. If in video mode, swipe in from left side of screen and touch .

Figure 38 Camera Mode



3. Frame the subject on the screen.
 4. To zoom in or out, press two fingers on the display and pinch or expand fingers. The zoom controls appear on the screen.
 5. Touch an area on the screen to focus. The focus circle appears on the screen.
 6. Touch .
- The camera takes a photo and a shutter sound plays.
- Alternately, touch  and hold to focus first, before taking a photo; then release to take a focused photo.

Recording Videos



IMPORTANT: ET5X does not support recording audio through a headset while recording video.

To record a video:







1. Touch  > .
2. If in photo mode, swipe in from left side of screen and touch .

Figure 39 Video Mode



3. Touch the options bar and touch .
4. Point the camera and frame the scene.
5. To zoom in or out, press two fingers on the display and pinch or expand fingers. The zoom controls appear on the screen.
6. Touch  to start recording.
The device starts recording the video. The video recording time appears in the top left of the screen.
7. Touch  to end recording.

Camera Settings

To change camera settings:

1. Swipe in from left.

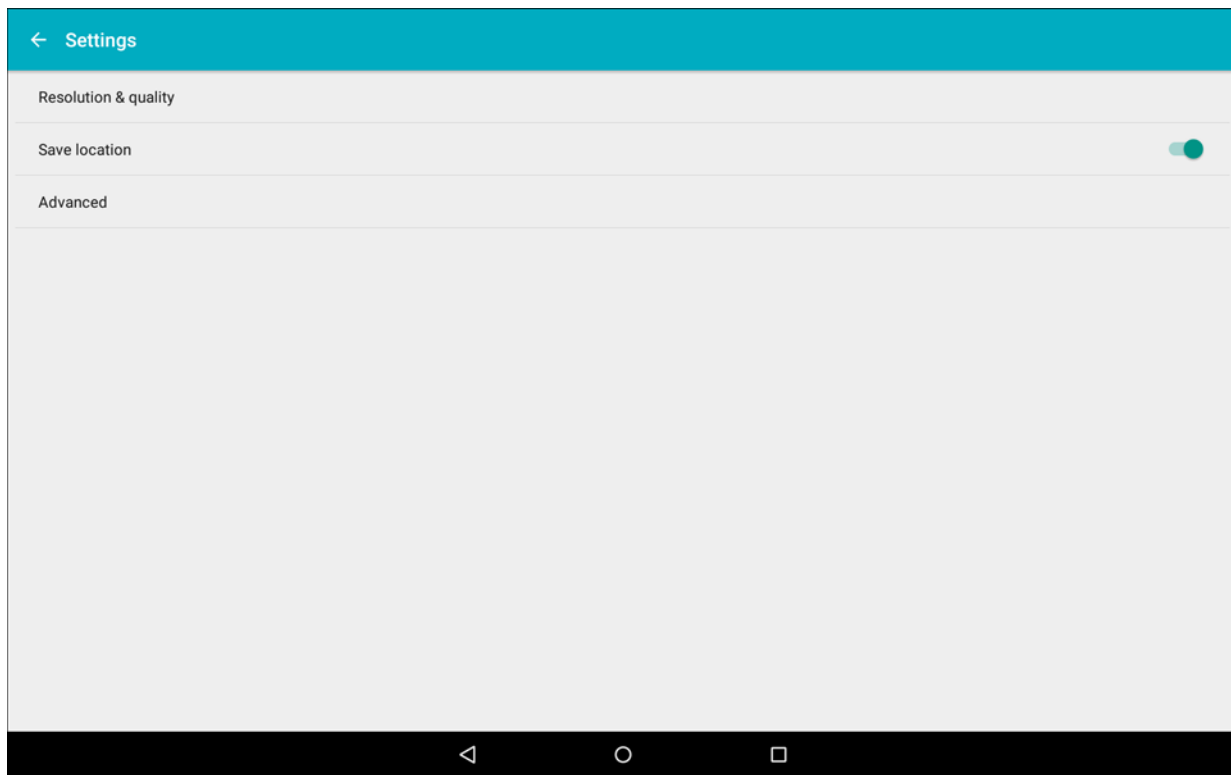
2. Touch .**Figure 40** Camera Settings**Resolution & quality**

- **Camera**
 - **Back camera photo**
 - (4:3) 8.0 megapixels
 - (4:3) 4.9 megapixels
 - (4:3) 3.1 megapixels
 - (16:9) 6.0 megapixels
 - (16:9) 2.1 megapixels
 - (16:9) 0.9 megapixels
 - **Front camera photo**
 - (16:9) 2.1 megapixels
 - (16:9) 0.9 megapixels
 - (4:3) 1.2 megapixels
 - (4:3) 0.3 megapixels
 - (4:3) 0.1 megapixels
- **Video**
 - **Back camera video**
 - HD 1080p
 - HD 720 p

- SD 480p
- **Front camera video**
 - HD 1080p
 - HD 720 p
 - SD 480p

Save location

Enable to add location information to the photo.

Advanced







- Manual exposure (default - off).

Photo Settings

When in Photo mode, photo settings display on screen.





Rear Camera

Touch  to display the photo setting options.

-  – Touch to switch to the front camera.
- **Flash mode** - Touch to set whether Rear-facing Camera relies on its light meter to decide whether a flash is necessary, or to turn it on or off for all shots.
 -  **Off** - Disable flash.
 -  **Auto** - Camera adjusts flash automatically depending upon light meter (default).
 -  **On** - Enable flash upon taking a photo.
-  **AE-Bracket** - Touch to set Automatic Exposure Bracketing (default – disabled).
-  **Countdown timer** - Options: **Off** (default), **3 seconds** or **10 seconds**.
-  **Exposure** - Touch to adjust the exposure settings. Options: +2, +1, 0 (default), -1 or -2. Available when Manual exposure is set in Advanced settings.

Front Camera

Touch  to display the photo setting options.





-  – Touch to switch to the rear camera.
-  **AE-Bracket** - Touch to set Automatic Exposure Bracketing (default – disabled).
-  **Countdown timer** - Options: **Off** (default), **3 seconds**, or **10 seconds**.
-  **Exposure** - Touch to adjust the exposure settings. Options: +2, +1, 0 (default), -1 or -2. Available when Manual exposure is set in Advanced settings.

Video Settings

When in Video mode, video settings are displayed on screen.



Rear Camera

Touch  to display the photo setting options.

-  – Touch to switch to the front camera.
- **Flash mode** - Touch to set whether Rear-facing Camera relies on its light meter to decide whether a flash is necessary, or to turn it on or off for all shots.
 -  **Off** - Disable flash (default).
 -  **On** - Enable flash upon taking a photo.
-  **AE-Bracket** - Touch to set Automatic Exposure Bracketing (default – disabled).

Front Camera

Touch  to display the photo setting options.

-  – Touch to switch to the rear camera.
-  **AE-Bracket** - Touch to set Automatic Exposure Bracketing (default – disabled).

Gallery



NOTE Gallery is only available on non-GMS devices. For GMS devices, use **Photos**.

The device supports the following image formats: jpeg, gif, png and bmp.

The device supports the following video formats: H.263, H.264 and MPEG4 Simple Profile.

Use Gallery to:

- view photos
- play videos
- perform basic editing of photos
- set photos as wallpaper
- set photos as a contact photo
- share photos and videos.

To open the Gallery application, touch  >  or in the camera application swipe from the right.

Gallery presents all photos and videos stored on the internal memory.

Figure 41 Gallery — Albums

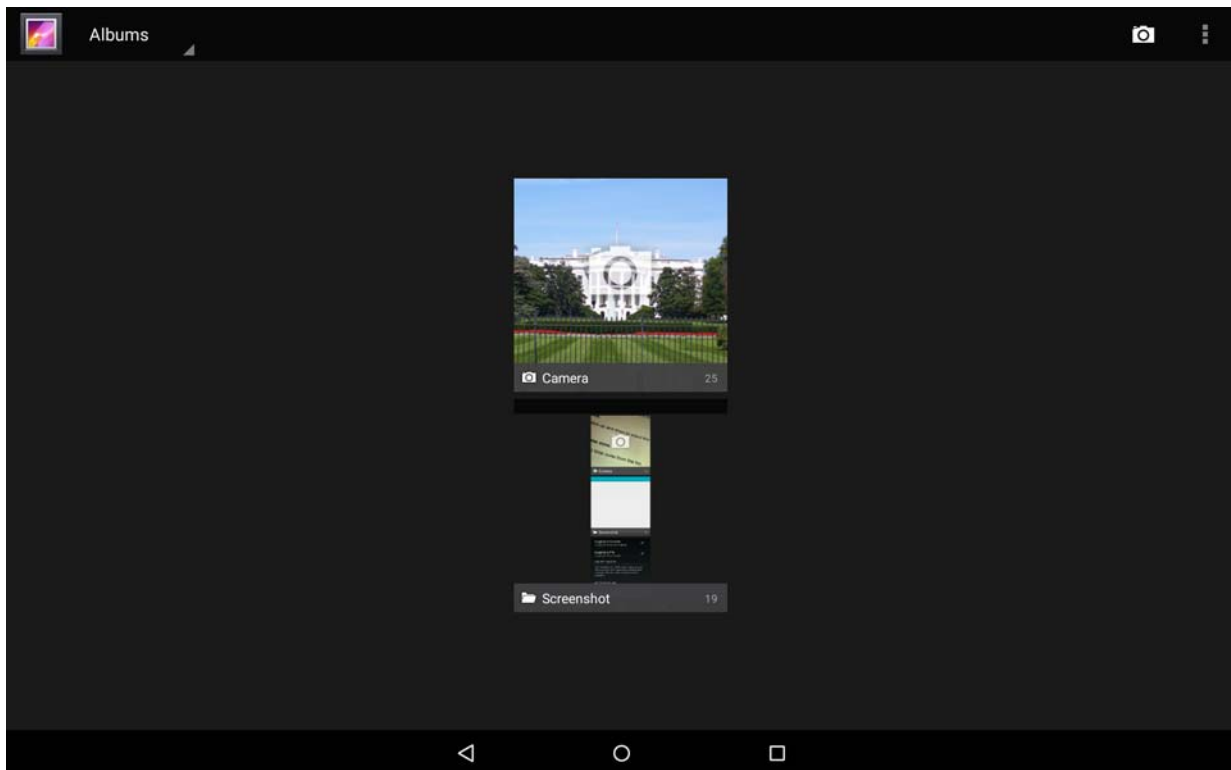

- Touch an album to open it and view its contents. The photos and videos in the album are displayed in chronological order.
- Touch a photo or video in an album to view it.

Working with Albums

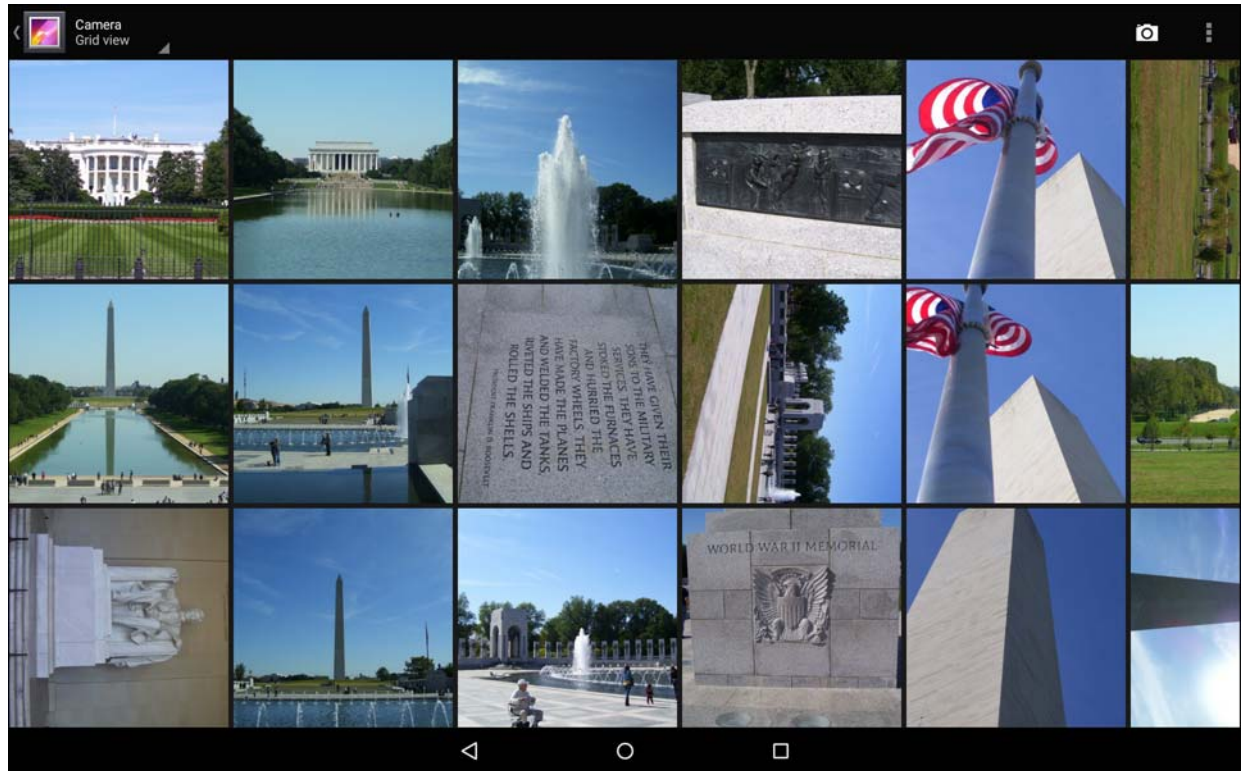

Albums are groups of images and videos in folders. Touch an album to open it. The photos and videos are listed in a chronologically ordered grid. The name of the album displays at the top of the screen.

Figure 42 Photos Inside an Album





Swipe left or right to scroll images across the screen.

Share an Album



1. Touch  > .
2. Touch and hold an album until it highlights.
3. Touch other albums as required.
4. Touch . The Share menu opens. Touch the application to use to share the selected albums.
5. Follow the instructions within the selected application.

Get Album Information

1. Touch  > .
2. Touch and hold an album until it highlights.
3. Touch .
4. Touch **Details**.

Deleting an Album

To delete an album and its contents:

1. Touch  > .
2. Touch and hold an album until it highlights.
3. Check other albums to delete. Ensure that other albums are selected.
4. Touch .
5. In the **Delete selected item?** menu, touch **OK** to delete the album.

Working with Photos

Use Gallery to view, edit and share photos.

Viewing and Browsing Photos

To view a photo:



1. Touch  > .
2. Touch an album to open it.
3. Touch a photo.

Figure 43 Photo Example

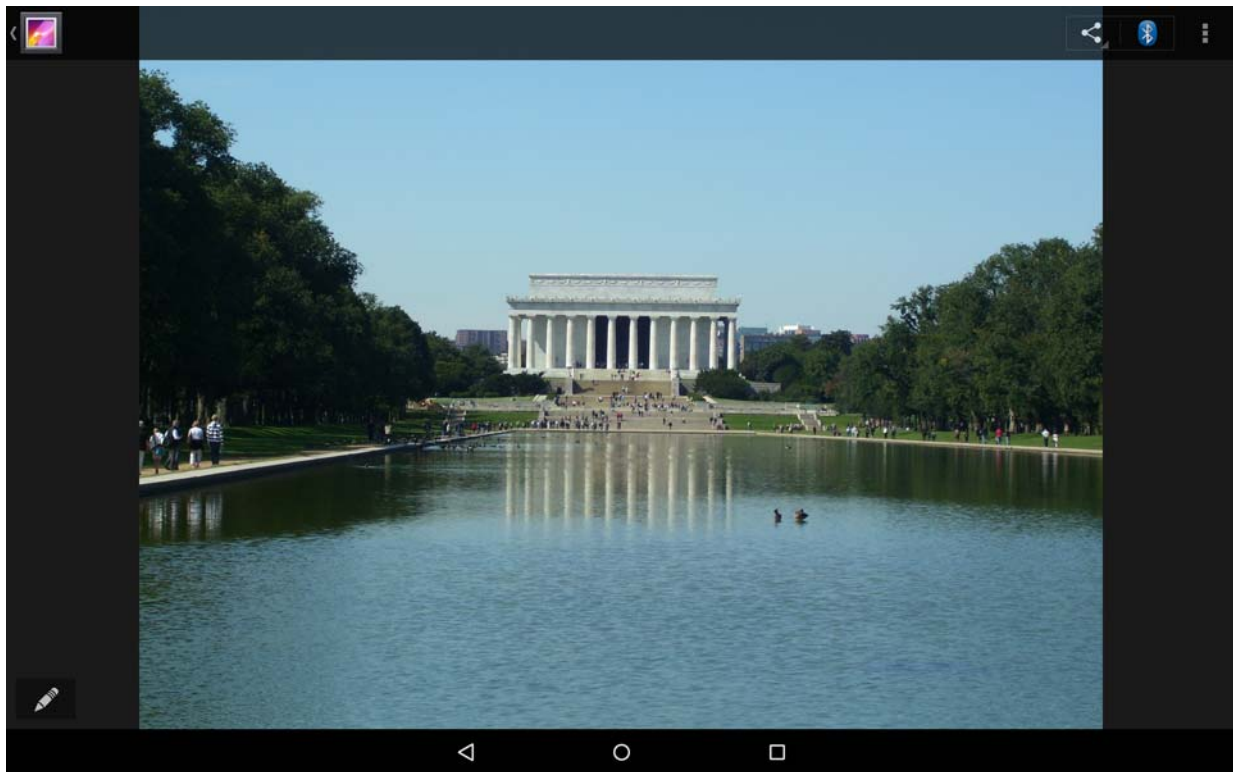

4. Swipe left or right to view the next or previous photo in the album.
5. Turn the device to view the photo in upright (portrait) or sideways (landscape) orientation. The photo is displayed (but not saved) in the new orientation.
6. Touch the photo to view the controls.
7. Double-tap the screen to zoom in or pinch two fingers together or spread them apart to zoom in or out.
8. Drag the photo to view parts that are not in view.

Rotating a Photo

1. Touch a photo to view the controls.
2. Touch .
3. Touch **Rotate Left** or **Rotate Right**.
The photo is automatically saved with the new orientation.

Cropping a Photo



1. In Gallery, touch a photo to view the controls.
2. Touch .
3. Touch **Crop**. The cropping tool appears.
4. Use the cropping tool to select the portion of the photo to crop.
 - Drag from the inside of the cropping tool to move it.
 - Drag an edge of the cropping tool to resize it to any proportion.
 - Drag a corner of the cropping tool to resize it with fixed proportions.

Figure 44 Cropping Tool



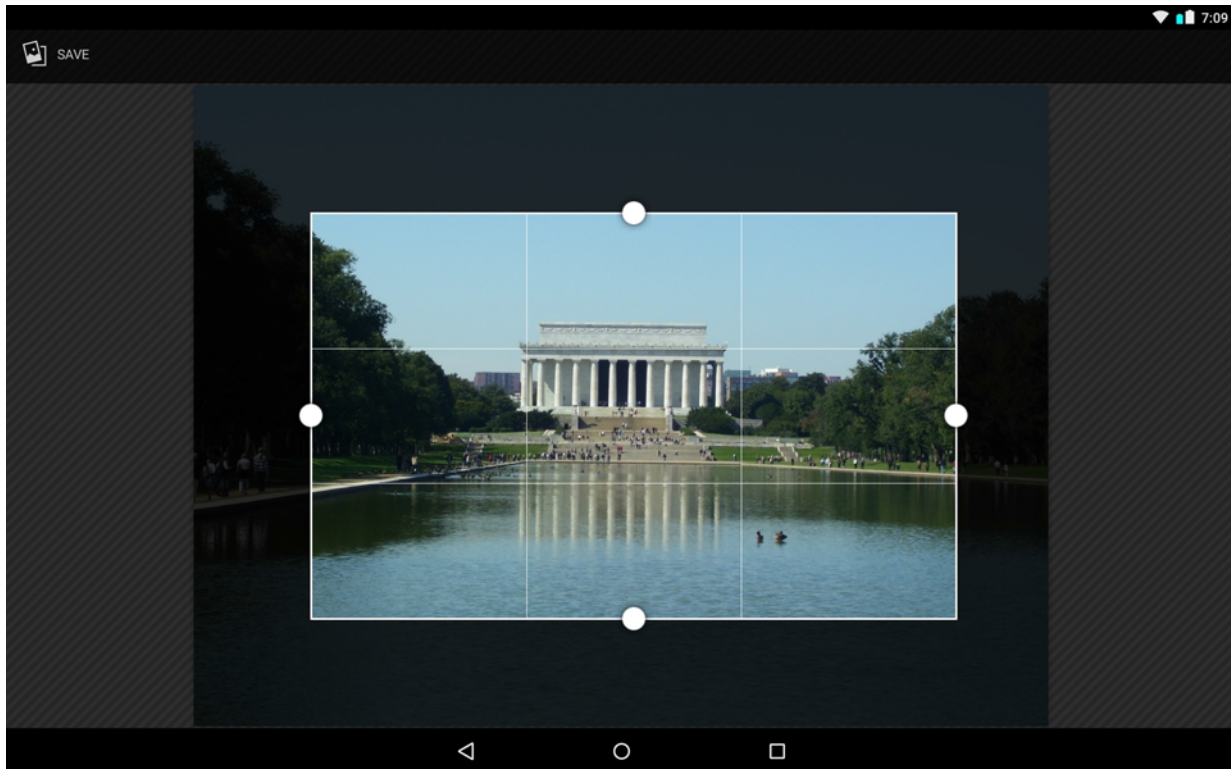

5. Touch **OK** or **Save** to save a copy of the cropped photo. The original version is retained.

Setting a Photo as a Contact Icon



1. Touch  > .
2. Touch an album to open it.
3. Touch the photo to open it.

4. Touch  .
5. Touch **Set picture as**.
6. Touch **Contact photo**.
7. In the **Contacts** application, touch a contact.
8. Touch the white box and crop the photo accordingly.
9. Touch **Save**.



Get Photo Information

1. Touch  > .
2. Touch an album to open it.
3. Touch the photo to open it.
4. Touch  .
5. Touch **Details**.
6. Touch **Close**.

Share a Photo

1. Touch  > .
2. Touch an album to open it.
3. Touch a photo to open it.
4. Touch .
5. Touch the application to use to share the selected photo. The application selected opens with the photo attached to a new message.

Deleting a Photo

1. Touch  > .
2. Touch an album to open it.
3. Touch a photo to open it.
4. Touch **Delete**.
5. Touch **OK** to delete the photo.

Working with Videos

Use Gallery to view videos and share videos.

Watching Videos







1. Touch  > .
2. Touch an album to open it.
3. Touch a video.

Figure 45 Video Example

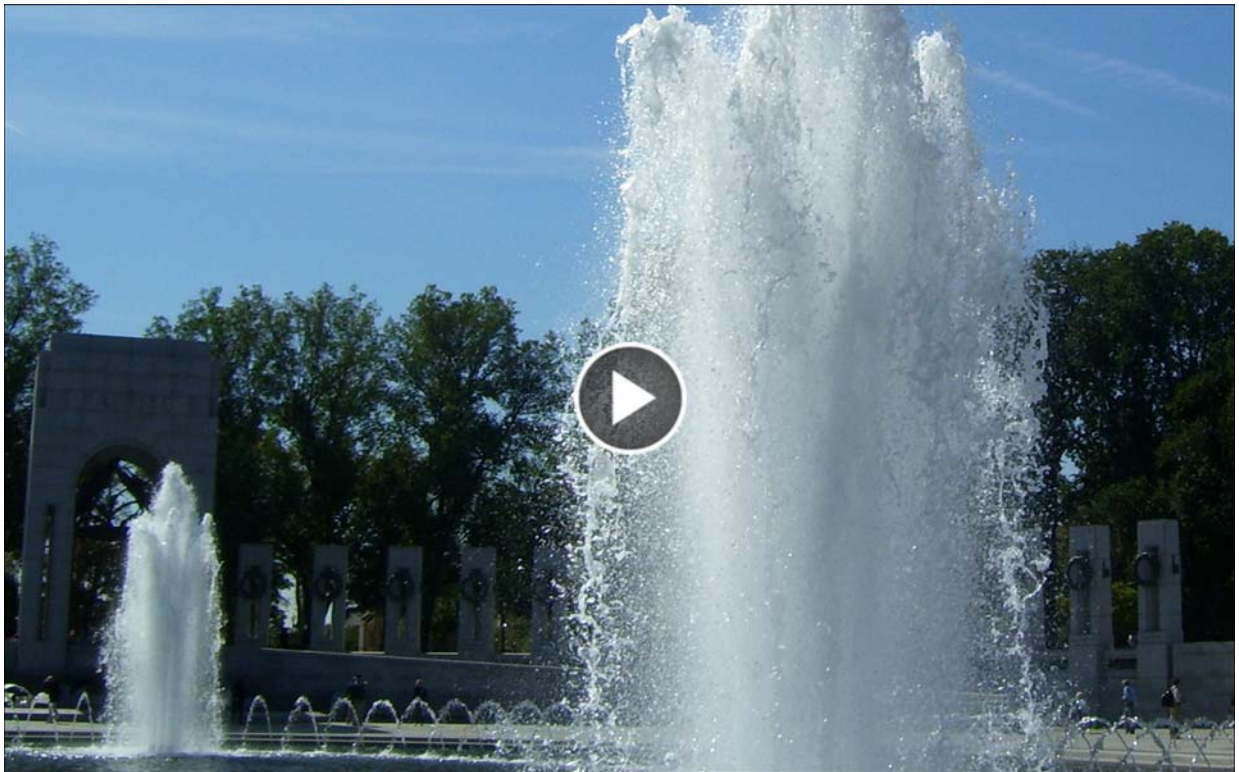

4. Touch . The video begins to play.
5. Touch the screen to view the playback controls.

Sharing a Video

1. Touch  > .
2. Touch an album to open it.
3. Touch a video to open it.
4. Touch . The Share menu appears.
5. Touch the application to use to share the selected video. The application selected opens with the video attached to a new message.

Deleting a Video

1. Touch  > .

2. Touch an album to open it.
3. Touch a video to open it.
4. Touch  > **Delete**.
5. Touch **OK**.

Contacts

Use the **Contacts** application to manage contacts.

From a Home or Apps screen, touch . **Contacts** opens to the main list of contacts. View contacts in three ways at the top of the screen: All contacts or Favorites. Touch the tabs to change how to view the contacts. Swipe up or down to scroll through the lists.

Adding a Contact

1. In the **Contacts** application, touch .
2. If there are more than one account with contacts, touch the one to use.
3. Type the contact's name and other information. Touch a field to start typing, and swipe down to view all categories.
4. To open a menu with preset labels, such as Home or Work for an email address, touch the label to the right of the item of contact information. Or, to create your own label, touch **Custom** in the menu.
5. Touch <- **Add New Contact**.

Editing Contacts

1. In the **Contacts** application, touch a contact name to edit.
2. Touch .
3. Edit the contact information.
4. Touch <- **Edit contact**.

Deleting Contacts

1. In the **Contacts** application, touch a contact name to delete.
2. Touch .
3. Touch **Delete**.
4. Touch **OK** to confirm.

Email



NOTE Only available on non-GMS devices. On GSM devices, use **GMail** application.

Use **Email** to send messages to other users. See [Email Setup on page 72](#) for information on setting up an Email account.

Creating an Email Message

To create an email message:

1. Touch  > **Email**.

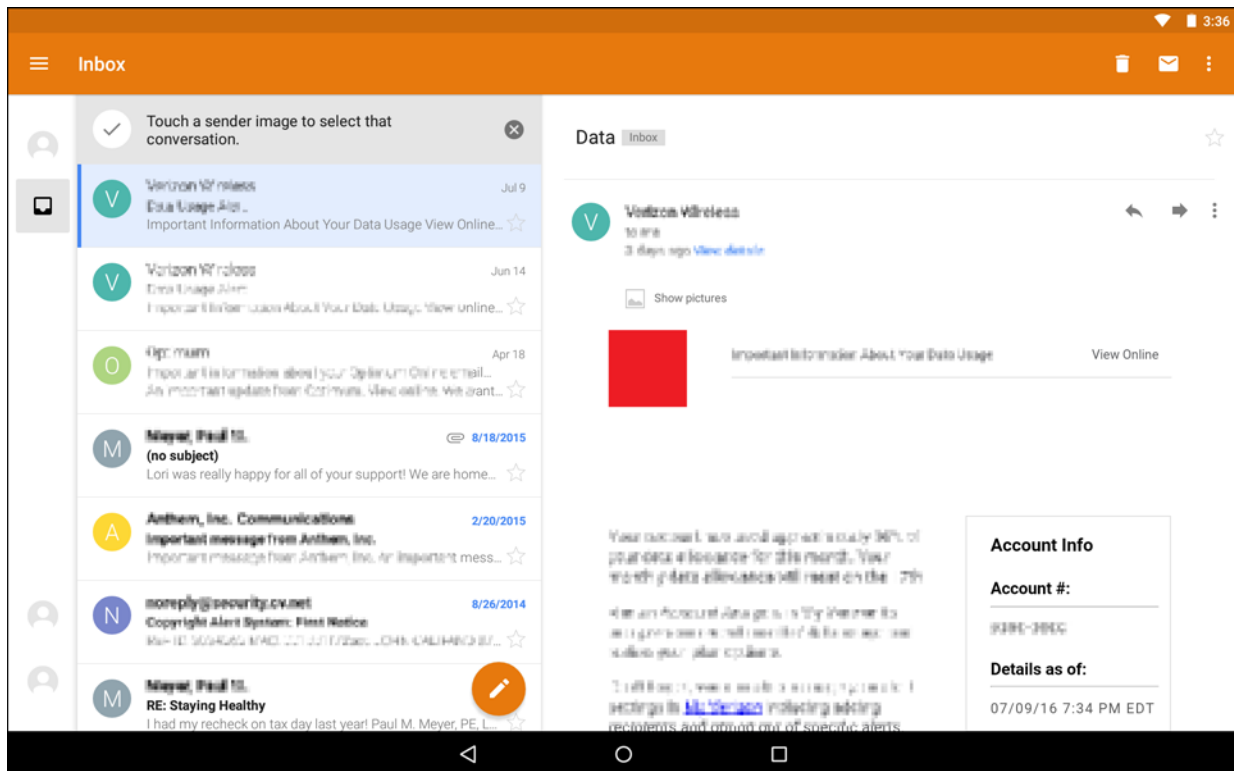

Figure 46 Email Inbox

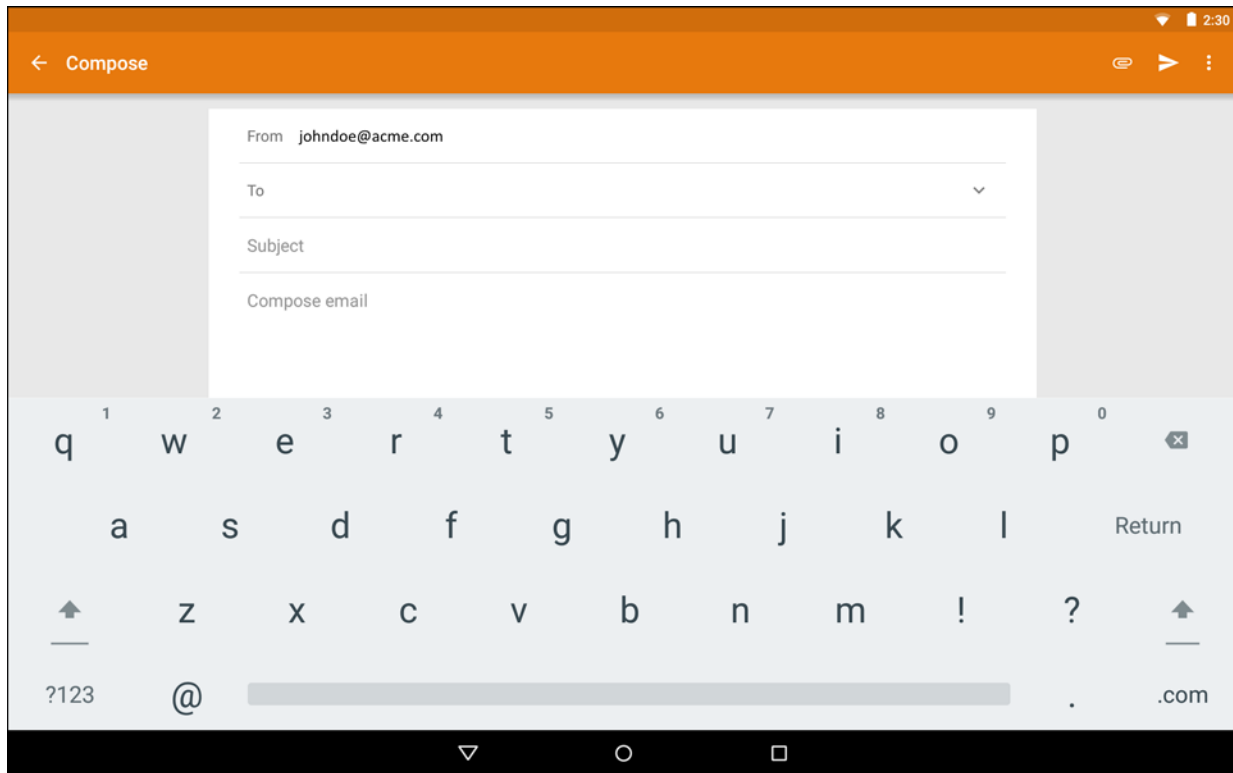

2. Touch .

Figure 47 New Email



3. To add recipients, enter their email addresses, separating them with a semicolon (;).
4. Enter a subject and compose the message.
5. To add an attachment to the message, touch  > **Attach file**.
6. Select an item to attach to the email.
7. Tap .



Viewing an Email Message

To view an email message:

1. Touch  > **Email**.
2. Tap an email to open it.

Replying to a Message

To reply to a message:

1. Touch  > **Email**.
2. Select an email account.
3. Tap an email to open it.
4. Tap .
5. Enter a reply message, and then touch .

Email Setup

The **Email** application lets users access and manage multiple email accounts simultaneously in one convenient location. To send and receive email messages through an ISP (Internet Service Provider) account, or to use the ET5X to access corporate email through a VPN (Virtual Private Network), first set up an account.



- IMAP (Internet Message Access Protocol) - This mail retrieval protocol is frequently used in large networks and commercial and institutional settings. IMAP4 is the current standard.
- POP (Post Office Protocol) - This protocol is supported by most ISPs and is currently more common among consumer applications. POP3 is the current standard.
- Exchange - This protocol connects to a Microsoft Exchange server.

Setting Up an IMAP or POP Account

When setting up an IMAP or POP account, the ET5X may be able to retrieve account settings automatically, or the user may need to enter certain settings manually. If the Automatic configuration was unsuccessful, or if accessing an account using a VPN server connection, contact the Internet Service Provider (ISP) or network administrator for the following information and enter it manually:

- Account type (IMAP4 or POP3)
- Incoming and outgoing mail server names
- Username and password
- Domain name
- Special security settings (if used).

To set up an email account:

1. Touch  > **Email**.
2. If at least one account is already set up in **Email**, touch  > **Settings** > **Add account**.
3. In the **Email address** text box, enter an email address.
4. Touch **Next** to allow **Email** to automatically attempt to configure the email account or touch **MANUAL SETUP** to manually set up the email account.
5. Select the type of email account: **Personal (POP3)** or **PERSONAL (IMAP)**. The **Sign in** screen appears.
6. In the **Password** text box, enter an associated password.
7. Touch **Next**. The **Incoming server settings** screen appears.
8. Configure the incoming server settings.
9. Touch **Next**. The **Outgoing server settings** screen appears.
10. Configure the outgoing server settings.
11. Touch **Next**. The **Account options** screen appears.
12. Set account options.
13. Touch **Next**.
14. Edit the account name, if required.
15. Touch **Next**. The email account is successful created.



Setting Up an Exchange Account

When setting up an Exchange account, the ET5X may be able to retrieve account settings automatically, or the user may need to enter certain settings manually. If the Automatic configuration was unsuccessful, or if accessing

an account using a VPN server connection, contact the Internet Service Provider (ISP) or network administrator for the following information and enter it manually:



- Account type (IMAP4 or POP3)
- Incoming and outgoing mail server names
- Username and password
- Domain name
- Special security settings (if used).

To set up an Exchange email account:

1. Touch  > Email.
2. If at least one account is already set up in **Email**, touch  > **Settings** > **Add account**.
3. In the **Email address** text box, enter an email address.
4. Touch **Next** to allow **Email** to automatically attempt to configure the email account or touch **MAUNUAL SETUP** to manually set up the email account. The **Account type** screen appears.
5. Touch **Exchange**.
6. In the **Password** text box, enter an associated password or if a certificate is required, touch **SELECT** and install the certificate. See system administrator for more information.
7. Touch **Next**. The **Incoming server settings** screen appears.
8. Configure the Incoming server settings.
9. Touch **Next**.
10. If the server requires security administration, a dialog box appears. Touch **OK**.
11. Set account options.
12. Touch **Next**.
13. If the server requires remote control of security features, a dialog box appears. Touch **Activate**.
14. Follow the instructions to set a lock screen PIN or password.
15. Touch **Next**.
16. Edit the an account name, if required.
17. Touch **Next**. The email account is successful created.

Editing an Email Account

To edit email settings such as account name, signature, quick responses, syncing and notifications:

1. Touch > Email.
2. Touch  > **Settings**.
3. Select an email account.
4. Make any changes if necessary.
5. Touch  to return to Email.

RxLogger

RxLogger is a comprehensive diagnostic tool that provides application and system metrics. It allows for custom plug-ins to be created and work seamlessly with this tool. RxLogger is used to diagnose device and application issues. Its information tracking includes the following: CPU load, memory load, memory snapshots, battery consumption, power states, wireless logging, cellular logging, TCP dumps, Bluetooth logging, GPS logging, logcat, FTP push/pull, ANR dumps, etc. All logs and files generated are saved onto flash storage on the device (internal or external).

Figure 48 RxLogger

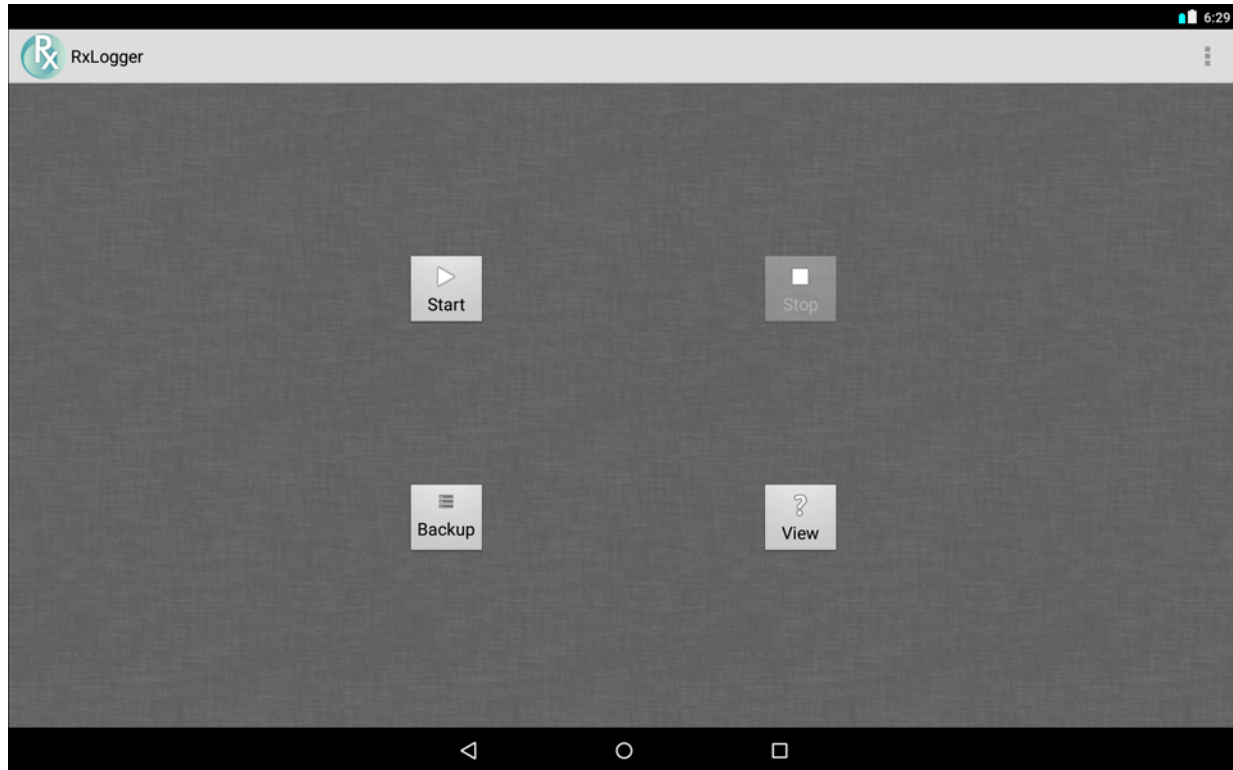

Elemesz



NOTE Elemesz collects specific device information in the background and sends this information to us to help improve product functionality. This feature can be disabled. See [Disabling Elemesz Data Collection on page 75](#).

Use **Elemesz** to provide diagnostics information to Zebra. Touch **Submit Diagnostics** button to send the data.

Figure 49 Elemesz Application

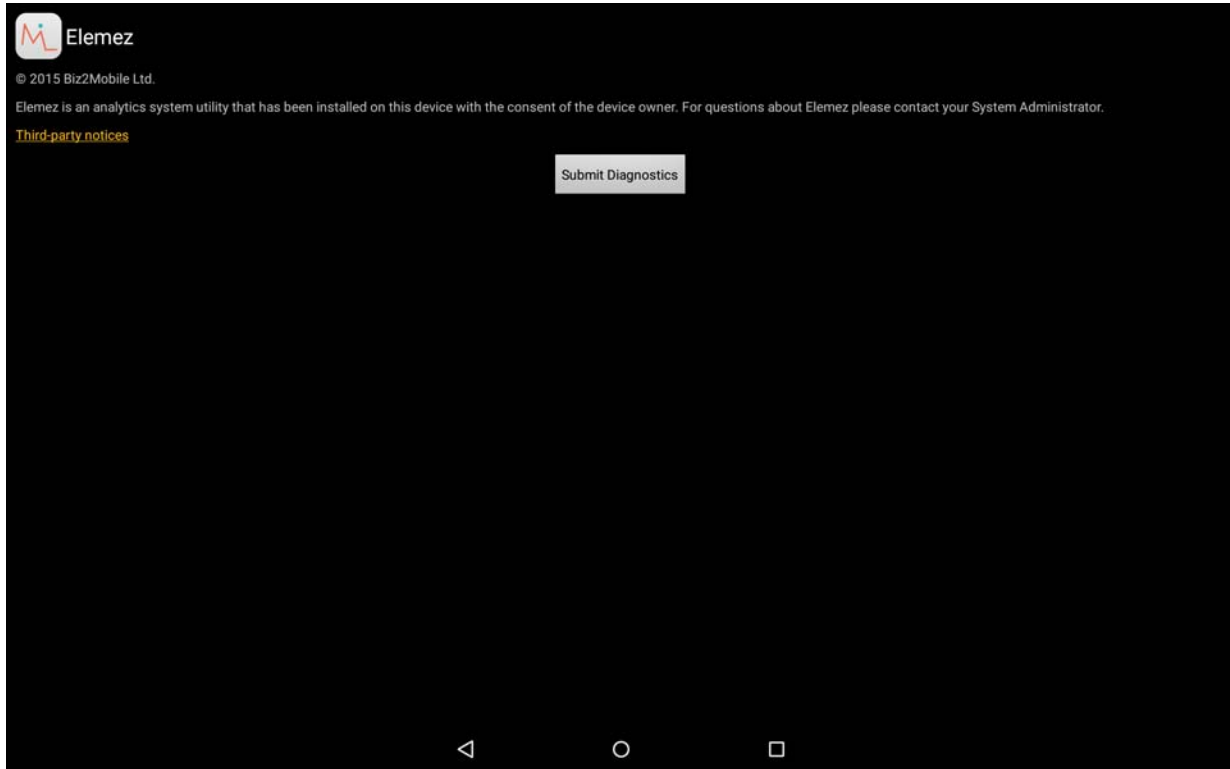





Disabling Elemesz Data Collection

The user can disable the **Elemesz** application from collection specific data in the background and sending it to Zebra Technologies.

1. From the Home screen, touch .
2. Touch **Apps**.
3. Scroll through the list and touch **Elemesz**.
4. Touch **FORCE STOP**.
5. Touch **OK**.
6. Touch **Disable**.
7. Touch **DISABLE APP**.
8. Touch **OK**.
9. Touch .

Enabling Elemez Data Collection

The user can re-enable the Elemez application for collection specific data in the background and sending it to Zebra Technologies.

1. From the Home screen, touch .
2. Touch **Apps**.
3. Scroll through the list and touch **Elemez**.
4. Touch **Enable**.
5. Touch .
6. Touch .
7. Touch .
8. Touch **Enable Elemez**.

Google Installed Application



NOTE For devices with GMS only.

For information on using Google installed applications, see www.google.com.

Wireless

This section provides information on the wireless features:

- Wireless Wide Area Network (WWAN)
- Wireless Local Area Network (WLAN)
- Bluetooth
- Near Field Communications (NFC).

Wireless Wide Area Networks

Use Wireless wide area networks (WWANs) to access data over a cellular network. This section provides information on:

- Sharing a data connection
- Disabling data roaming
- Monitoring data usage
- Limiting connections to 2G networks
- Locking a SIM card
- Editing Access Point Names (APNs).

Sharing the Mobile Data Connection

The **tethering & portable hotspot** settings allow you to share your data connection. You can share the ET55's mobile data connection with a single computer via USB tethering or Bluetooth tethering. You can also share the data connection with up to eight devices at once, by turning it into a portable Wi-Fi hotspot. While the ET55 is sharing its data connection, an icon appears at the top of the screen and a corresponding message appears in the notification list.

USB Tethering



NOTE USB tethering is not supported on computers running Mac OS. If your computer is running Windows 7 or a recent version of Linux (such as Ubuntu), follow these instructions without any special preparation. If running a version of Windows that precedes Windows 7, or some other operating system, you may need to prepare the computer to establish a network connection via USB.

1. Connect the ET55 to a host computer with the USB cable.

A USB icon appears at the top of the screen, and the notification **Connected as a media device** or **Connected as a camera** appears briefly at the top of the screen.

2. Swipe down with two fingers from the status bar to open the quick access panel and then touch .
3. Touch **More**
4. Touch **Tethering & portable hotspot**.
5. Check **USB tethering**.

The host computer is now sharing the ET55's data connection.

To stop sharing the data connection, uncheck **USB tethering** or disconnect the USB cable.

Bluetooth Tethering

Use Bluetooth tethering to share the data connection with a host computer.

Configure the host computer to obtain its network connection using Bluetooth. For more information, see the host computer's documentation.

1. Pair the ET55 with the host computer.
2. Swipe down with two fingers from the status bar to open the quick access panel and then touch .
3. Touch **More**
4. Touch **Tethering & portable hotspot**.
5. Check **Bluetooth tethering**.

The host computer is now sharing the ET55's data connection.

To stop sharing the data connection, uncheck **Bluetooth tethering**.

Portable Wi-Fi Hotspot

Configure the Wi-Fi Hotspot settings.

1. Swipe down with two fingers from the status bar to open the quick access panel and then touch .
2. Touch **More**
3. Touch **Tethering & portable hotspot**.
4. Check **Portable Wi-Fi hotspot**.

After a moment, the ET55 starts broadcasting its Wi-Fi network name (SSID), so you can connect to it with up to eight computers or other devices.

To stop sharing the data connection, uncheck **Portable Wi-Fi hotspot**.

Configuring the Wi-Fi Hotspot

1. Swipe down with two fingers from the status bar to open the quick access panel and then touch .
2. Touch **More**
3. Touch **Tethering & portable hotspot**.
4. Touch **Set up Wi-Fi hotspot**.

Figure 50 Set up Wi-Fi Hotspot Dialog Box

5. In the **Network SSID** text field, edit the network name.
6. Touch the **Country** option and select the country you are in from the drop-down list.
7. In the **Select AP Band** drop-down list, select either **2.4 GHz Band** or **5 GHz Band**.
8. Touch the **Channel** option and select a channel number from the drop-down list.
9. Touch the **Security** option and select a security method from the drop-down list.
 - **None**
 - **WPA2 PSK**
10. In the **Password** text field, enter a password.



NOTE If **None** is selected in the **Security** option, a password is not required.

11. Touch **Save**.

Data Usage

1. Data usage refers to the amount of data uploaded or downloaded by the ET55 during a given period. Depending on the wireless plan, you may be charged additional fees when your data usage exceeds your plan's limit. To monitor your data usage, swipe down with two fingers from the status bar to open the quick access panel and then touch .



CAUTION The usage displayed on the data usage settings screen is measured by your device. Your carrier's data usage accounting may differ. Usage in excess of your carrier plan's data limits can result in steep overage charges. The feature described here can help you track your usage, but is not guaranteed to prevent additional charges.

Data usage settings allow you to:

- Set the data usage level at which you'll receive a warning.
- Set a data usage limit.
- View or restrict data usage by app.
- Identify mobile hotspots and restrict background downloads that may result in extra charges.

By default, when you open the data usage settings screen you see the settings for mobile data: that is, the data network or networks provided by your carrier:

Figure 51 Data Usage Screen

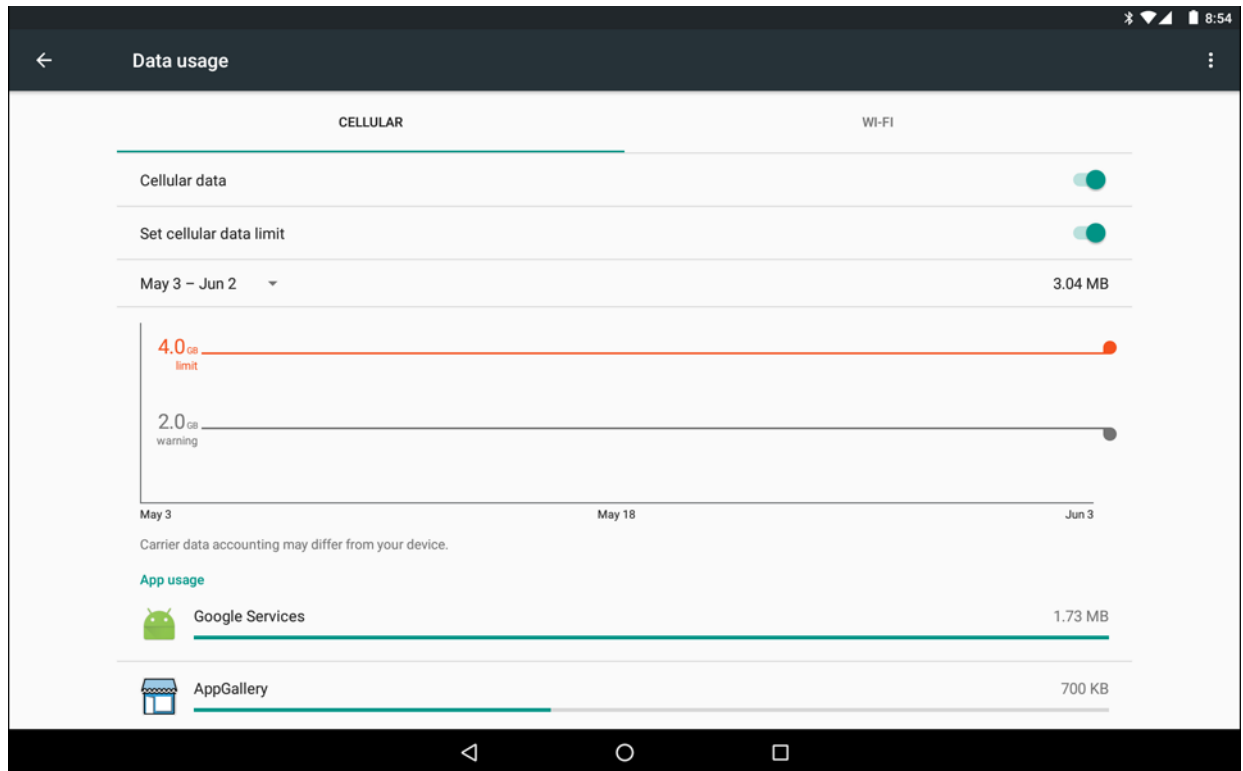

To display Wi-Fi data usage settings in a separate tab touch  > **Show Wi-Fi**.

Just below the on-off switch, note the data usage cycle. Touch it to choose a different cycle. This date range is the period of time for which the graph displays data usage.

The vertical white lines on the graph show a period of time within the data usage cycle. This range determines the usage amount displayed just below the graph. Drag lines to change the period.

Set Data Usage Warning

Drag the orange line by its right side to the level where you want to receive a warning. When your data usage reaches this level, you'll receive a notification.

Set Auto-Sync

You can also conserve data usage by syncing your apps manually, only when you need the data, rather than relying on auto-sync. To turn auto-sync off or on, touch  > **Restrict background data**.

Disabling Data When Roaming

To prevent the device from transmitting data over other carriers' mobile networks when leaving an area that is covered by the carrier's networks. This is useful for controlling expenses if the service plan does not include data roaming.

1. Swipe down with two fingers from the status bar to open the quick access panel and then touch .
2. Touch **More**

3. Touch **Mobile networks**.
4. Slide the **Data roaming** switch to the off position.

Locking the SIM Card

Locking the SIM card requires the user to enter a PIN every time the device is turned on. If the correct PIN is not entered, only Emergency calls can be made.



1. Swipe down with two fingers from the status bar to open the quick access panel and then touch .
2. Touch  **Security**.
3. Touch **Set up SIM/RUIM card lock**.
4. Touch **Lock SIM card**.

Figure 52 Enter PIN to Lock SIM Card





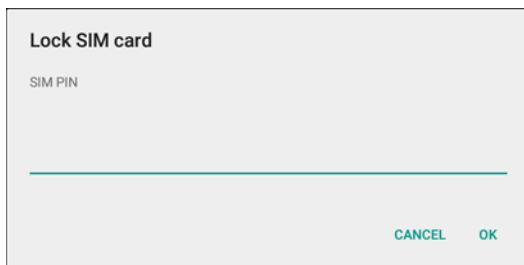

5. Enter the PIN associated with the card. Touch **OK**.
6. Reset the device.

Editing the Access Point Name



NOTE Many service provider Access Point Name (APN) data are pre-configured in the device. The APN information for all other service providers must be obtained from the wireless service provider.

To use the data on a network the user must configure the APN information.

1. Swipe down with two fingers from the status bar to open the quick access panel and then touch .
2. Touch **More**
3. Touch **Cellular networks**.
4. Touch **Access Point Names**.
5. Touch an APN name in the list to edit an existing APN or touch  to create a new APN.
6. Touch each APN setting and enter the appropriate data obtained from the wireless service provider.
7. When finished, touch .
8. Touch **Save**.
9. Touch the radio button next to the APN name to start using it.
10. Touch .

Wireless Local Area Networks

Wireless local area networks (WLANs) allow the ET5X to communicate wirelessly inside a building. Before using the ET5X on a WLAN, the facility must be set up with the required hardware to run the WLAN (sometimes known as infrastructure). The infrastructure and the ET5X must both be properly configured to enable this communication.

Refer to the documentation provided with the infrastructure (access points (APs), access ports, switches, Radius servers, etc.) for instructions on how to set up the infrastructure.

Once the infrastructure is set up to enforce the chosen WLAN security scheme, use the **Wireless & networks** settings configure the ET5X to match the security scheme.

The ET5X supports the following WLAN security options:

- Open
- Wireless Equivalent Privacy (WEP).
- Wi-Fi Protected Access (WPA/WPA2) Personal (PSK).
- Extensible Authentication Protocol (EAP).
 - Protected Extensible Authentication Protocol (PEAP) - with MSCHAPV2 and GTC authentication.
 - Transport Layer Security (TLS)
 - TTLS - with Password Authentication Protocol (PAP), MSCHAP and MSCHAPv2 authentication.
 - LEAP.

The **Status** bar displays icons that indicate Wi-Fi network availability and Wi-Fi status. See [Status Bar on page 38](#) for more information.



NOTE Turn off Wi-Fi when not using it, to extend the life of the battery.

Scan and Connect to a Wi-Fi Network



1. Swipe down with two fingers from the status bar to open the quick access panel and then touch .
2. Touch  **Wi-Fi**.
3. If off, slide the **Wi-Fi** switch to the **ON** position. The ET5X searches for WLANs in the area and lists them.



Figure 53 Wi-Fi Screen

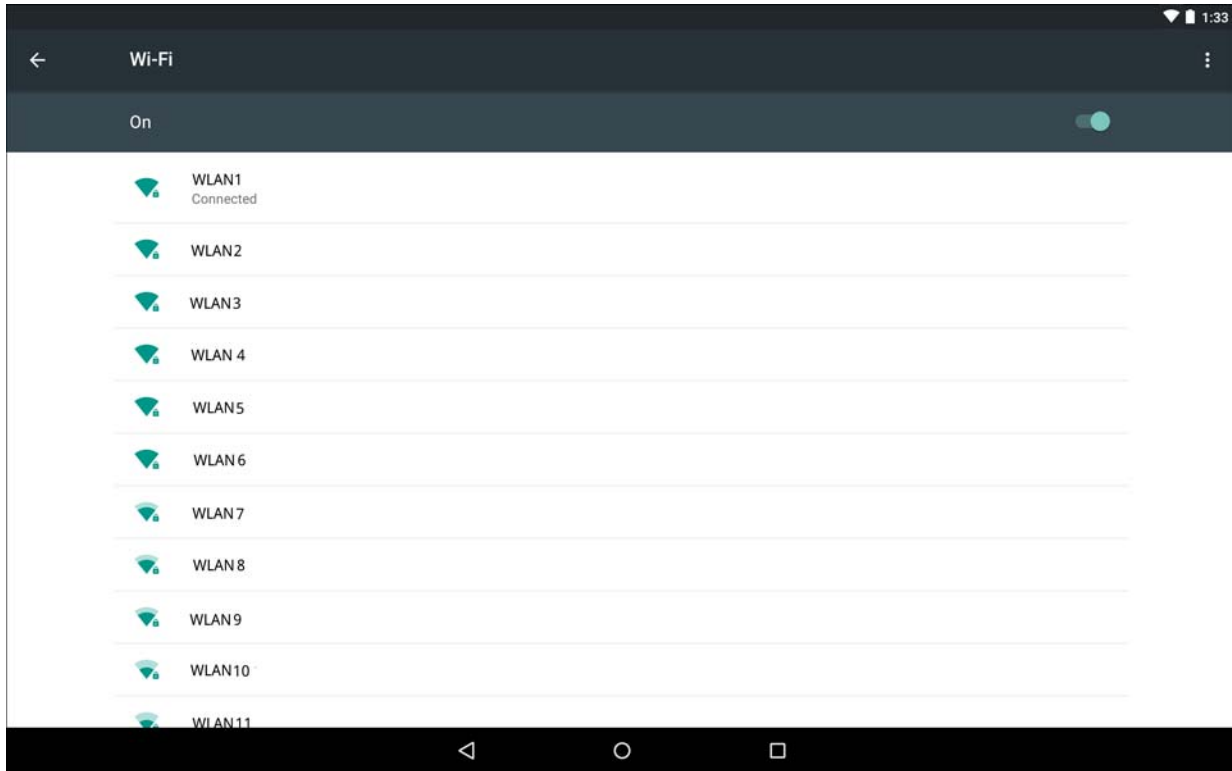

4. Scroll through the list and select the desired WLAN network.
5. For open networks, touch profile once or press and hold and then select **Connect to network** or for secure networks enter the required password or other credentials then touch **Connect**. See the system administrator for more information.
6. The ET5X obtains a network address and other required information from the network using the dynamic host configuration protocol (DHCP) protocol. To configure the ET5X with a fixed internet protocol (IP) address, See [Configuring the Device to Use a Static IP Address on page 87](#).
7. In the Wi-Fi setting field, **Connected** appears indicating that the ET5X is connected to the WLAN.

Configuring a Wi-Fi Network

To set up a Wi-Fi network:

1. Swipe down with two fingers from the status bar to open the quick access panel and then touch .
2. Touch  **Wi-Fi**.
3. If off, slide the switch to the **ON** position.
4. The device searches for WLANs in the area and lists them on the screen.
5. Scroll through the list and select the desired WLAN network.
6. Touch the desired network. If the network security is **Open**, the device automatically connects to the network. For all other network security a dialog box appears.
7. If the network security is **WEP** or **WPA/WPS2 PSK**, enter the required password and then touch **Connect**.
8. If the network security is 802.1x EAP:
 - Touch the EAP method drop-down list and select **PEAP**, **TLS**, **TTLS**, or **LEAP**.
 - Touch the **Phase 2 authentication** drop-down list and select an authentication method.

- If required, touch **CA certificate** and select a Certification Authority (CA) certificate. Note: Certificates are installed using the **Security** settings.
- If required, touch **User certificate** and select a user certificate. Note: User certificates are installed using the Location & security settings.
- If required, in the **Identity** text box, enter the username credentials.
- If desired, in the **Anonymous identity** text box, enter an anonymous identity username.
- If required, in the **Password** text box, enter the password for then given identity.





NOTE By default, the network Proxy is set to **None** and the IP settings is set to **DHCP**. See [Configuring for a Proxy Server on page 86](#) for setting connection to a proxy server and see [Configuring the Device to Use a Static IP Address on page 87](#) for setting the device to use a static IP address.

9. Touch **Connect**.
10. Touch .

Manually Adding a Wi-Fi Network

Manually add a Wi-Fi network if the network does not broadcast its name (SSID) or to add a Wi-Fi network when out of range.

1. Swipe down with two fingers from the status bar to open the quick access panel and then touch .
2. Touch  **Wi-Fi**.
3. If off, slide the Wi-Fi switch to the **On** position.
4. Touch  **> Add network**.
5. In the **Enter the SSID** text box, enter the name of the Wi-Fi network.
6. In the **Security** drop-down list, select the type of security. Options:
 - **None**
 - **WEP**
 - **WPA/WPA2 PSK**
 - **802.1x EAP**.
7. If the network security is **None**, touch **Save**.
8. If the network security is **WEP** or **WPA/WPA2 PSK**, enter the required password and then touch **Save**.
9. If the network security is **802.1x EAP**:
 - Touch the **EAP method** drop-down list and select **PEAP, TLS, TTLS, LEAP**.
 - Touch the **Phase 2 authentication** drop-down list and select an authentication method.
 - If required, touch **CA certificate** and select a Certification Authority (CA) certificate. Note: Certificates are installed using the **Security** settings.
 - If required, touch **User certificate** and select a user certificate. Note: User certificates are installed using the **Security** settings.
 - If required, in the **Identity** text box, enter the username credentials.
 - If desired, in the **Anonymous identity** text box, enter an anonymous identity username.
 - If required, in the **Password** text box, enter the password for then given identity.

- ✓ By default, the network Proxy is set to **None** and the IP settings is set to **DHCP**. See [Configuring for a Proxy Server on page 86](#) for setting connection to a proxy server and see [Configuring the Device to Use a Static IP Address on page 87](#) for setting the device to use a static IP address.

1. Touch **SAVE**.
2. Touch .

Configuring for a Proxy Server

A proxy server is a server that acts as an intermediary for requests from clients seeking resources from other servers. A client connects to the proxy server, requesting some service, such as a file, connection, web page, or other resource, available from a different server. The proxy server evaluates the request according to its filtering rules. For example, it may filter traffic by IP address or protocol. If the request is validated by the filter, the proxy provides the resource by connecting to the relevant server and requesting the service on behalf of the client.

It is important for enterprise customers to be able to set up secure computing environments within their companies, and proxy configuration is an essential part of doing that. Proxy configuration acts as a security barrier ensuring that the proxy server monitors all traffic between the Internet and the intranet. This is normally an integral part of security enforcement in corporate firewalls within intranets.

1. In the **Wi-Fi** list, touch a network.
2. Touch **Advanced options** checkbox.
3. Touch **Proxy settings** and select **Manual**.

Figure 54 Proxy Settings

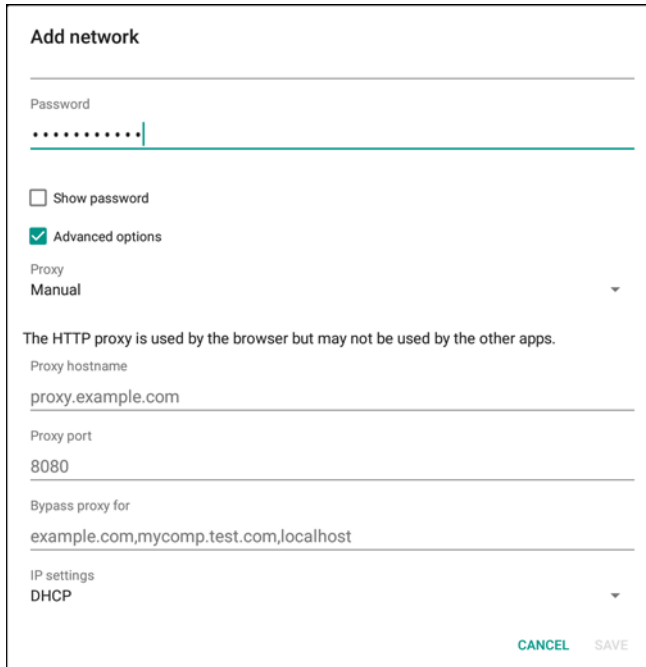

The screenshot shows the 'Add network' settings screen. At the top, there is a 'Password' field with a masked password. Below it is a 'Show password' checkbox, which is unchecked. The 'Advanced options' checkbox is checked. Under 'Advanced options', the 'Proxy' setting is set to 'Manual'. A note states: 'The HTTP proxy is used by the browser but may not be used by the other apps.' Below this, there are three text input fields: 'Proxy hostname' with the value 'proxy.example.com', 'Proxy port' with the value '8080', and 'Bypass proxy for' with the value 'example.com,mycomp.test.com,localhost'. At the bottom, the 'IP settings' are set to 'DHCP'. There are 'CANCEL' and 'SAVE' buttons at the bottom right.

4. In the **Proxy hostname** text box, enter the address of the proxy server.
5. In the **Proxy port** text box, enter the port number for the proxy server.



NOTE When entering proxy addresses the Bypass proxy for field, do not use spaces or carriage returns between addresses.

6. In the **Bypass proxy for** text box, enter addresses for web sites that do not require to go through the proxy server. Use the separator “|” between addresses.
7. Touch **Connect**.
8. Touch .

Configuring the Device to Use a Static IP Address

By default, the device is configured to use Dynamic Host Configuration Protocol (DHCP) to assign an Internet protocol (IP) address when connecting to a wireless network. To configure the device to connect to a network using a static IP address:

1. In the **Wi-Fi** list, touch a network.
2. Touch **Show advanced options** checkbox.
3. Touch **IP settings** and select **Static**.

Figure 55 Static IP Settings

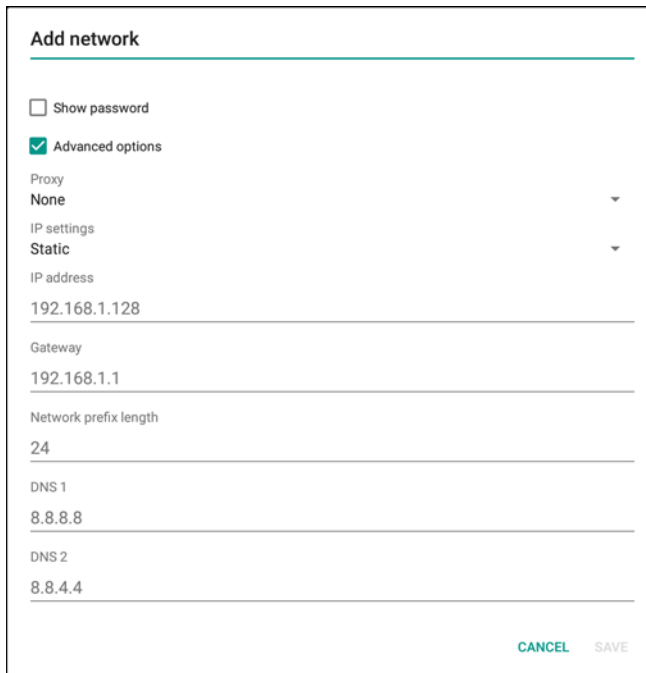

The screenshot shows the 'Add network' settings screen. At the top, there is a title 'Add network' and a horizontal line. Below the title, there are two checkboxes: 'Show password' (unchecked) and 'Advanced options' (checked). Under 'Advanced options', there are several settings:

- Proxy:** Set to 'None' with a dropdown arrow.
- IP settings:** Set to 'Static' with a dropdown arrow.
- IP address:** Text box containing '192.168.1.128'.
- Gateway:** Text box containing '192.168.1.1'.
- Network prefix length:** Text box containing '24'.
- DNS 1:** Text box containing '8.8.8.8'.
- DNS 2:** Text box containing '8.8.4.4'.

At the bottom right, there are two buttons: 'CANCEL' and 'SAVE'.

4. In the **IP address** text box, enter an IP address for the device.
5. If required, in the **Gateway** text box, enter a gateway address for the device.
6. If required, in the **Network prefix length** text box, enter a the prefix length.
7. If required, in the **DNS 1** text box, enter a Domain Name System (DNS) address.
8. If required, in the **DNS 2** text box, enter a DNS address.
9. Touch **Connect**.
10. Touch .

Advanced Wi-Fi Settings



NOTE Advanced Wi-Fi settings are for the device not for a specific wireless network.

- **Network notification** - When enabled, notifies the user when an open network is available.
- **Keep Wi-Fi on during sleep** - Opens a menu to set whether and when the Wi-Fi radio turns off.
 - **Always On** - The radio stays on when the device enters suspend mode.
 - **Only when plugged in** - The radio stays on while the device is connected to external power.
 - **Never** - The radio turns off when the device enters suspend mode (default).
- **Wi-Fi frequency band** - Use to select the frequency band. Options: **Automatic** (default), **5 GHz only** or **2.4 GHz only**.
- Wi-Fi Direct
- WPS Push Button
- WPS Pin Entry
- **Install Certificates** – Touch to install certificates. See *ET5X Integrator Guide* for more information.
- **MAC address** - Displays the Media Access Control (MAC) address of the device when connecting to Wi-Fi networks.
- **IP address** - Displays the IP address of the device.

Additional Settings

- **Regulatory**
 - **Country selection** - Displays the acquired country code if **Auto** is selected else displays the selected country code. Default: **Auto**.
 - **Region code** - Displays the configured region code for the device.
- **Band and Channel Selection**
 - **Wi-Fi frequency band** - Use to select the frequency band. Options: **Auto** (default), **5 GHz only** or **2.4 GHz only**.
 - **Available channels (2.4 GHz)** - Use to select specific channels. Touch to display the **Available channels** menu. Select specific channels. Touch **OK**.
 - **Available channels (5 GHz)** - Use to select specific channels. Touch to display the **Available channels** menu. Select specific channels. Touch **OK**.
- **Logging**
 - **Advanced Logging** – Touch to enable advanced logging.
 - **Wireless logs** - Use to capture Wi-Fi log files.
 - **Fusion Logger** - Touch to open the **Fusion Logger** application. This application maintains a history of high level WLAN events which helps to understand the status of connectivity.

Figure 56 Fusion Logger Screen



- **Fusion Status** - Touch to display live status of WLAN state. Also provides information of device and connected profile.

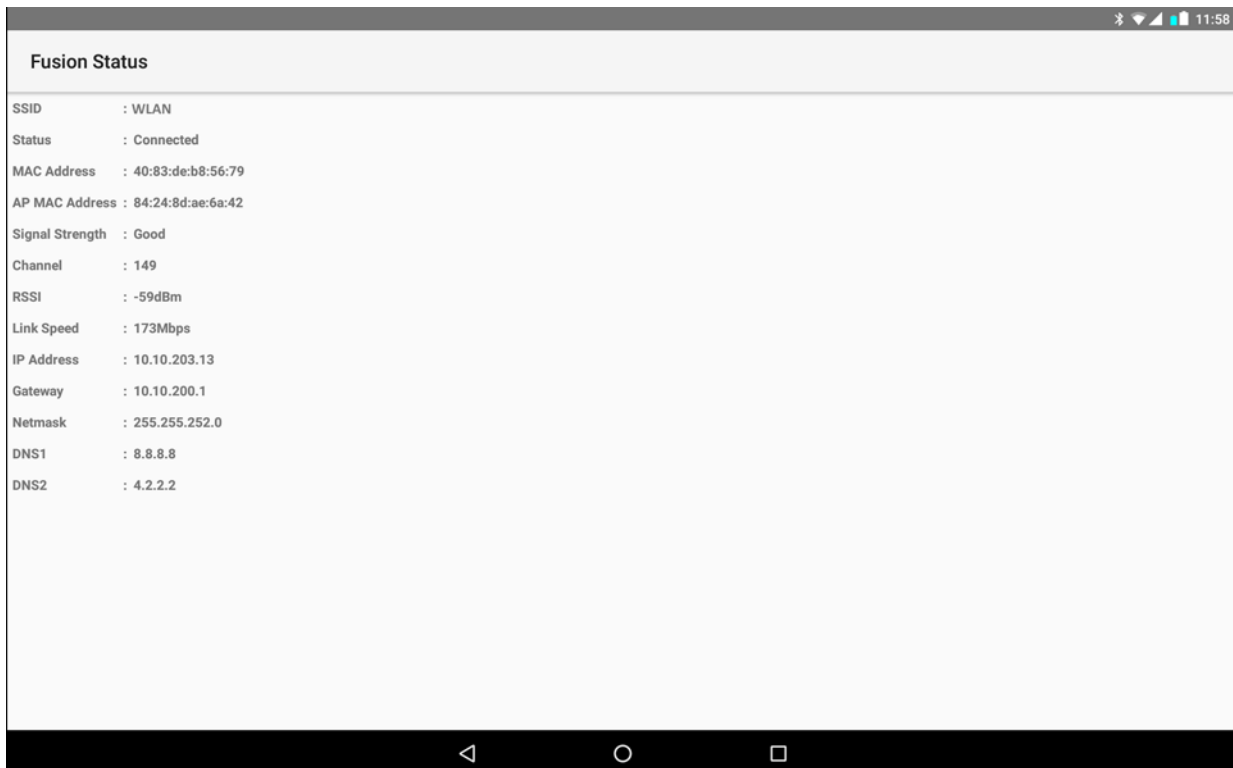

Figure 57 Fusion Status Screen



- **About**
 - **Version** - Displays the current Fusion information.

Remove a Wi-Fi Network

To remove a remembered or connected network:

1. Swipe down with two fingers from the status bar to open the quick access panel and then touch .
2. Touch  **Wi-Fi**.
3. In the **Wi-Fi networks** list, touch and hold the name of the network.
4. In the menu, touch **Forget network**.
5. Touch .

Wi-Fi Advanced Features

Some additional Wi-Fi settings cannot be accessed from the User Interface. They can be configured by using Wi-Fi (CSP). Refer to EMDK documentation for the details on the Wi-Fi settings configuration using the Wi-Fi CSP.

- **Auto Time Config** - Using this feature, the device can sync up its time with Zebra WLAN infrastructure. This feature works only when the device is connected to Zebra WLAN infrastructure and the feature is enabled on the WLAN infrastructure side. Default: disabled.
- **PMKID Caching** - Allows the device to skip 802.1x authentication during roaming if it had previously connected to that AP with a full 802.1x authentication. Default: disabled. Note: disable OKC when enabling PMKID Caching.
- **Opportunistic Key Caching** - Use this feature to skip 802.1x authentication during roaming. The device will go for full 802.1x authentication for the first time it connects to the network. For subsequent roaming, the device skips 802.1x authentication. Default: enabled.
- **Cisco Centralized Key Management** - Allows the device to skip 802.1x and key-handshake phases during roaming. This feature is available only when the device is connected to a Cisco infrastructure that supports Cisco Centralized Key Management (CCKM). Default: enabled.
- **Fast Transition** - Fast Transition (FT) is the fast roaming standard, 802.11r. With this feature, the device can skip 802.1x and key-handshake phases during roam. Default: enabled.
- **Fast Transition Resource Information Container** - Allows the device to request TSPEC as part of reassociation frame exchange. This helps to avoid sending a separate resource request after roaming is completed. Default: disabled.
- **Power Save** - The device can be configured to work in different power save modes:
 - **Active** - Keeps the WLAN radio always in active mode (i.e. power save mode disabled).
 - **Power save using WMM-PS** - This is the default power save mode. Device uses WMM-PS power save method if the AP is configured to use this. If the AP is not supporting WMM-PS, the device will use PS-Poll power save method.
 - **Power save using PS-Poll** - In this method, the device will use PS-Poll frames to retrieve buffered frames from the AP.
 - **Null Data Power Save** - In Null Data Power Save (NDP), the device will stay awake for 100 ms after the last frame is sent or received. The device will send a Null Data packet with power management bit cleared to retrieve buffered frames from the AP.
- **802.11k** - Using 802.11k, the device can discover neighbor APs and adds support for different types of radio resource measurements. Default: enabled.

- **Band Preference** - The device can be configured to prefer one band over another. By default, device prefers 5 GHz frequency band over 2.4 GHz.
- **Subnet Roaming** - When the device roams between different sub networks, if it detects that it is roaming to a different subnet, the device will request a fresh IP address. Default: disabled.

Zebra Mobility Extensions

Zebra Mobility Extensions make use 802.11 specifications and Zebra proprietary extensions to achieve the highest level of performance, efficiency and reliability. The ET5X adds support for the following Zebra Mobility Extensions.

- **Coverage Hole Detection** - The ET5X includes enhancements to the IEEE 802.11k standard. These improvements will report gaps in signal coverage to the Zebra wireless LAN infrastructure. Network administrators can detect and mitigate coverage gaps present in the network for greater reliability. Default: enabled.
- **Aggregated Fast Transition** - Aggregated FT improves on IEEE 802.11r, Over-the-DS fast roaming. In conjunction with Zebra wireless LAN infrastructure, the ET5X will achieve more reliable and consistent fast roaming. Default: enabled.
- **Scan Assist** - The ET5X monitors neighbor access points and retrieves roaming related information from the Zebra wireless LAN infrastructure without doing scans. Using this Scan Assist feature, the ET5X improves roaming. Default: enabled.

Bluetooth

Bluetooth-equipped devices can communicate without wires, using frequency-hopping spread spectrum (FHSS) radio frequency (RF) to transmit and receive data in the 2.4 GHz Industry Scientific and Medical (ISM) band (802.15.1). Bluetooth wireless technology is specifically designed for short-range (10 meters (32.8 feet)) communication and low power consumption.

Devices with Bluetooth capabilities can exchange information (e.g., files, appointments, and tasks) with other Bluetooth enabled devices such as printers, access points, and other mobile devices.

Adaptive Frequency Hopping

Adaptive Frequency Hopping (AFH) is a method of avoiding fixed frequency interferers, and can be used with Bluetooth voice. All devices in the piconet (Bluetooth network) must be AFH-capable in order for AFH to work. There is no AFH when connecting and discovering devices. Avoid making Bluetooth connections and discoveries during critical 802.11b communications. AFH for Bluetooth consists of four main sections:

- **Channel Classification** - A method of detecting an interference on a channel-by-channel basis, or pre-defined channel mask.
- **Link Management** - Coordinates and distributes the AFH information to the rest of the Bluetooth network.
- **Hop Sequence Modification** - Avoids interference by selectively reducing the number of hopping channels.
- **Channel Maintenance** - A method for periodically re-evaluating the channels.

When AFH is enabled, the Bluetooth radio “hops around” (instead of through) the 802.11b high-rate channels. AFH coexistence allows Enterprise devices to operate in any infrastructure.

The Bluetooth radio in this device operates as a Class 2 device power class. The maximum output power is 2.5 mW and the expected range is 10 meters (32.8 ft.). A definition of ranges based on power class is difficult to obtain due to power and device differences, and whether one measures open space or closed office space.



NOTE It is not recommended to perform Bluetooth wireless technology inquiry when high rate 802.11b operation is required.

Security

The current Bluetooth specification defines security at the link level. Application-level security is not specified. This allows application developers to define security mechanisms tailored to their specific need. Link-level security occurs between devices, not users, while application-level security can be implemented on a per-user basis. The Bluetooth specification defines security algorithms and procedures required to authenticate devices, and if needed, encrypt the data flowing on the link between the devices. Device authentication is a mandatory feature of Bluetooth while link encryption is optional.

Pairing of Bluetooth devices is accomplished by creating an initialization key used to authenticate the devices and create a link key for them. Entering a common personal identification number (PIN) in the devices being paired generates the initialization key. The PIN is never sent over the air. By default, the Bluetooth stack responds with no key when a key is requested (it is up to user to respond to the key request event). Authentication of Bluetooth devices is based-upon a challenge-response transaction. Bluetooth allows for a PIN or passkey used to create other 128-bit keys used for security and encryption. The encryption key is derived from the link key used to authenticate the pairing devices. Also worthy of note is the limited range and fast frequency hopping of the Bluetooth radios that makes long-distance eavesdropping difficult.

Recommendations are:

- Perform pairing in a secure environment
- Keep PIN codes private and do not store the PIN codes in the device
- Implement application-level security.

Bluetooth Profiles

The device supports the following Bluetooth services:

- Service Discovery Protocol (SDP) - Handles the search for known and specific services as well as general services.
- Serial Port Profile (SPP) - Allows use of RFCOMM protocol to emulate serial cable connection between two Bluetooth peer devices. For example, connecting the device to a printer.
- Advanced Audio Distribution Profile (A2DP) - Allows the device to stream stereo-quality audio to a wireless headset or wireless stereo speakers.
- Audio/Video Remote Control Profile (AVRCP) - Allows the device to control A/V equipment to which a user has access. It may be used in concert with A2DP.
- Human Interface Device Profile (HID) - Allows Bluetooth keyboards, pointing devices, gaming devices and remote monitoring devices to connect to the device.
- Object Push Profile (OPP) - Allows the device to push and pull objects to and from a push server.
- Personal Area Network (PAN) - Allows the use of Bluetooth Network Encapsulation Protocol to provide L3 networking capabilities over a Bluetooth link. Only PANU and PAN-NAP role are supported.
- Generic Object Exchange Profile (GOEP) - Provides a basis for other data profiles. Based on OBEX.
- Generic Access Profile (GAP) - Provides the basis for all other profiles. GAP defines how two Bluetooth devices discover and establish a connection with each other.
- Generic Audio/Video Distribution Profile (GAVDP) - Provides the basis for A2DP and VDP, the basis of the systems designed for distributing video and audio streams using Bluetooth technology.

- Message Access Profile (MAP) - Allows exchange of messages between devices.
- Out of Band (OOB) - Allows exchange of information used in the pairing process. Pairing is completed using the Bluetooth radio, but requires information from the OOB mechanism. Using OOB with NFC enables pairing when devices simply get close, rather than requiring a lengthy discovery process.

Bluetooth Power States

The Bluetooth radio is off by default.

- Suspend - When the ET5X goes into suspend mode, the Bluetooth radio stays on.
- Airplane Mode - When the ET5X is placed in Airplane Mode, the Bluetooth radio turns off. When Airplane mode is disabled, the Bluetooth radio returns to the prior state. When in Airplane Mode, the Bluetooth radio can be turned back on if desired.





Bluetooth Radio Power

Turn off the Bluetooth radio to save power or if entering an area with radio restrictions (e.g., an airplane). When the radio is off, other Bluetooth devices cannot see or connect to the device. Turn on the Bluetooth radio to exchange information with other Bluetooth devices (within range). Communicate only with Bluetooth radios in close proximity.





NOTE To achieve the best battery life turn off radios when not in use.

Enabling Bluetooth



1. Swipe down with two fingers from the status bar to open the quick access panel and then touch .
2. Touch  **Bluetooth**.
3. Slide the switch to the right. **ON** appears and  appears in the Status bar.
4. Touch .

Disabling Bluetooth

1. Touch  **Bluetooth**.
2. Slide the switch to the left. **OFF** appears.
3. Touch .

Discovering Bluetooth Device(s)

The ET5X can receive information from discovered devices without pairing. However, once paired, the ET5X and a paired device exchange information automatically when the Bluetooth radio is on. To find Bluetooth devices in the area:

1. Ensure that Bluetooth is enabled on both devices.
2. Ensure that the Bluetooth device to discover is in discoverable mode.
3. Ensure that the two devices are within 10 meters (32.8 feet) of one another.
4. Swipe down with two fingers from the status bar to open the quick access panel and then touch .
5. Touch  **Bluetooth**.

- The ET5X begins searching for discoverable Bluetooth devices in the area and displays them under **Available devices**.
- Scroll through the list and select a device. The **Bluetooth pairing request** dialog box appears.

Figure 58 Bluetooth Pairing

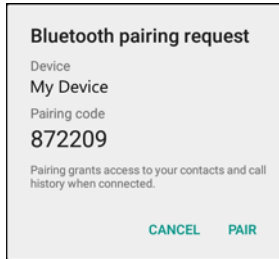





NOTE For older Bluetooth devices, Enter a PIN in the text box and touch **OK**. Enter the same PIN on the other device.

- Touch **Pair** on both devices.
- The Bluetooth device is added to the **Paired devices** list and a trusted (“paired”) connection is established.



Changing the Bluetooth Name

By default, the ET5X has a generic Bluetooth name that is visible to other devices when connected.

- Swipe down with two fingers from the status bar to open the quick access panel and then touch .
- Touch  **Bluetooth**.
- If Bluetooth is not on, slide the switch to the **ON** position.
- Touch .
- Touch **Rename this device**.
- Enter a name and touch **Rename**.
- Touch .

Connecting to a Bluetooth Device



Once paired, connect to a Bluetooth device.

- Swipe down with two fingers from the status bar to open the quick access panel and then touch .
- Touch  **Bluetooth**.
- If Bluetooth is off, slide the switch to the **ON** position.
- In the **Paired devices** list, touch and hold on a unconnected Bluetooth device until a menu appears.
- Touch **Connect**. When connected, the device is displayed as connected in the list.

Selecting Profiles on the Bluetooth Device





Some Bluetooth devices have multiple profiles. To select a profile:

- Swipe down with two fingers from the status bar to open the quick access panel and then touch .

2. Touch  **Bluetooth**.
3. In the **Paired devices** list, touch  next to the device name.
4. Under **Use for**, check or uncheck a profile to allow the device to use that profile.
5. Touch **OK**.
6. Touch .

Unpairing a Bluetooth Device

To unpair a Bluetooth device and erase all pairing information:

1. Swipe down with two fingers from the status bar to open the quick access panel and then touch .
2. Touch  **Bluetooth**.
3. In the **Paired devices** list, touch  next to the device name.
4. Touch **FORGET**.
5. Touch .

Near Field Communications

NFC/HF RFID is a short-range wireless connectivity technology standard that enables secure transaction between a reader and a contactless smart card. The technology is based on ISO/IEC 14443 type A and B (proximity), Felica and ISO/IEC 15693 (vicinity) standards, using the HF 13.56 MHz unlicensed band. The ET5X supports three operating modes:

- Reader mode
- Peer-to-Peer communication
- Card Emulation mode.



NOTE See [Technical Specifications](#) for information on NFC card support.

Using NFC, the ET5X can:

- Read contactless cards such as contactless tickets, NFC labels, HF tokens or standard smart cards.
- Read and write information to contactless cards such as SmartPosters and tickets, as well as devices with NFC interface such as vending machines.
- Read information from supported medical sensors.
- Pair with supported Bluetooth devices such as printers and headsets.
- Exchange data with another NFC device.
- Emulate contactless card such as ticket or V-card.

The ET5X NFC antenna is uniquely positioned to read NFC cards from the front of the device.

Reading NFC Cards and RFID Tags

The ET5X supports reading NFC cards and RFID tags. The NFC antenna is located on the back of the device under the NFC logo.

1. Make sure NFC is turned on.
 - a. Touch **Settings > More**.
 - b. Ensure that the NFC switch is in the on (green) position.
 - c. Touch Home.
2. Launch an NFC enabled application.
3. Hold device as shown.

Figure 59 Reading NFC Card

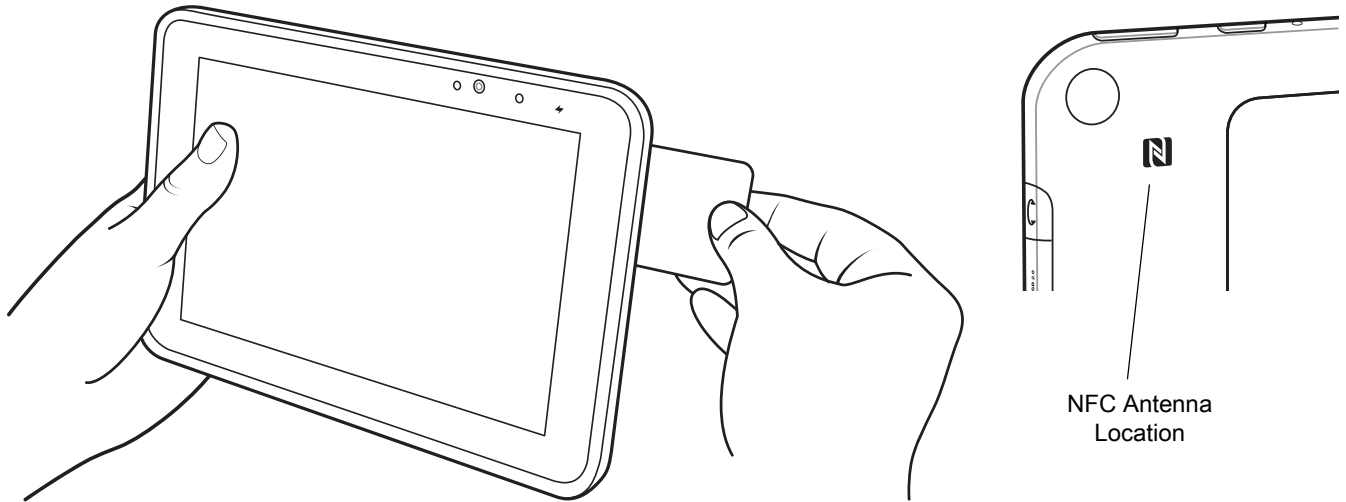

4. Move NFC card until the ET5X detects the card.
5. Hold the card steadily until the transaction is complete (usually indicated by the application).

Data Capture

The ET5X supports data capture using:

- SE4750 Expansion Back
- RS507 hands-free Imager
- RS6000 scanner (supported on BSP 02-14-30 and above)
- DS3608SR/ER USB scanners (supported on BSP 02-14-30 and above)
- DS3678 SR/ER Bluetooth scanners (supported on BSP 02-14-30 and above).

Expansion Back

The Expansion Backs are bar code scanning solutions for both 1D and 2D bar code symbologies. Expansion Backs are available in the following configurations:

- SE4750 Expansion Back for 8" tablet
- SE4750 Expansion Back for 10" tablet.

Install the Expansion Back prior to use. Refer to the ET5X Integration Guide for installation instructions.

RS507 Hands-Free Imager

The RS507 Hands-free Imager is a wearable bar code scan solution for both 1D and 2D bar code symbologies. The scanner supports Bluetooth Human Interface Device (HID) connection to the device.

Figure 60 RS507 Hands-Free Imager

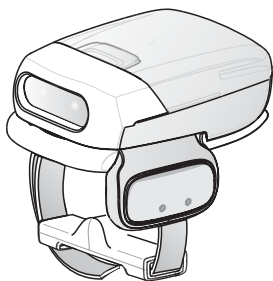

See to the RS507 Hands-free Imager Product Reference Guide for more information.

RS6000 Bluetooth Ring Scanner

The RS6000 Bluetooth Ring Scanner is a wearable barcode scan solution for both 1D and 2D barcode symbologies.

Figure 61 RS6000 Bluetooth Ring Scanner

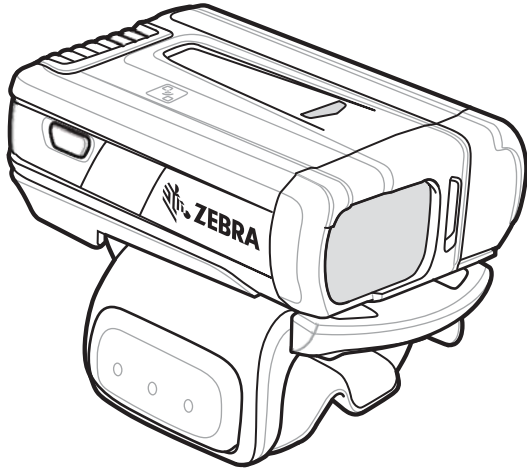

Refer to the RS6000 Bluetooth Ring Scanner Product Reference Guide for more information.

Scanning Considerations

Scanning consists of; aim, scan and decode. Scanning performance can be optimized by considering the range and the scanning angle:

- Range

Any scanning device decodes well over a particular working range (minimum and maximum distances from the bar code). This range varies according to bar code density and scanning device optics.

Scanning within range brings quick and constant decodes; scanning too close or too far away prevents decodes. Move the scanner closer and further away to find the right working range for the bar codes being scanned. However, the situation is complicated by the availability of various integrated scanning modules. The best way to specify the appropriate working range per bar code density is through a chart called a decode zone for each scan module. A decode zone simply plots working range as a function of minimum element widths of bar code symbols.

- Angle

The scan angle is important for optimizing decode performance. When laser beams reflect directly back into the scanner from the bar code, this specular reflection can “blind” the scanner.

To avoid this, scan the bar code so that the beam does not bounce directly back. But do not scan at too sharp an angle; the scanner needs to collect scattered reflections from the scan to make a successful decode. Practice quickly shows what tolerances to work within.



NOTE Contact the Zebra Global Customer Support if chronic scanning difficulties develop. Decoding of properly printed bar codes should be quick and effortless.

Imaging

The imagers have the following features:

- Omnidirectional (360°) reading of a variety of bar code symbologies, including the most popular linear, postal, PDF417, and 2D matrix code types.
- The ability to capture and download images to a host for a variety of imaging applications.
- Advanced intuitive laser aiming for easy point-and-shoot operation.

The imager uses digital camera technology to take a digital picture of a bar code, stores the resulting image in its memory, and executes state-of-the-art software decoding algorithms to extract the data from the image.

Bar Code Capture Using the SE4750 Expansion Back

To read a bar code:

1. Launch an application.
2. Ensure that the text field is in focus.
3. Point the Expansion Back exit window at a bar code.

Figure 62 Bar Code Scanning with Expansion Back with SE4750

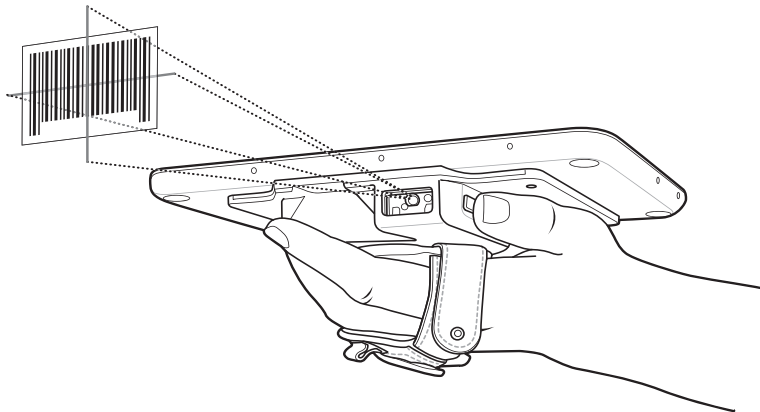

4. Press and hold the Scan button.

The red laser aiming pattern turns on to assist in aiming. Ensure the bar code is within the area formed by the cross-hairs in the aiming pattern. The aiming dot is used for increased visibility in bright lighting conditions.

The Expansion Back beeps to indicate the bar code was decoded successfully.

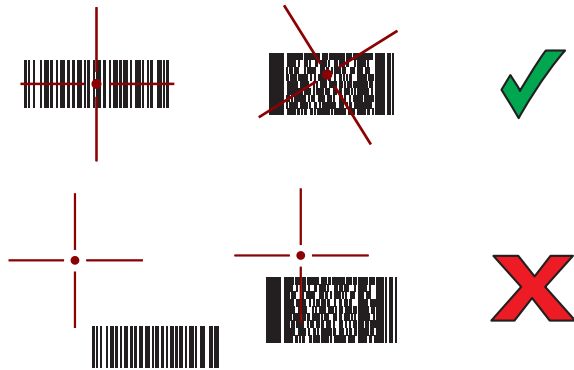
Figure 63 SE4750 Expansion Back Aiming Pattern

5. Release the Scan button. The bar code data displays on the screen.

Bar Code Capture Using RS507 Hands-Free Imager

Pair the RS507 with the ET5x. See [Pairing the RS507/RS6000 Using SSI on page 104](#) or [Pairing the RS507/RS6000 Using HID on page 104](#) for more information.

1. Ensure that an application is open on the device and a text field is in focus (text cursor in text field).
2. Point the RS507 at a bar code.

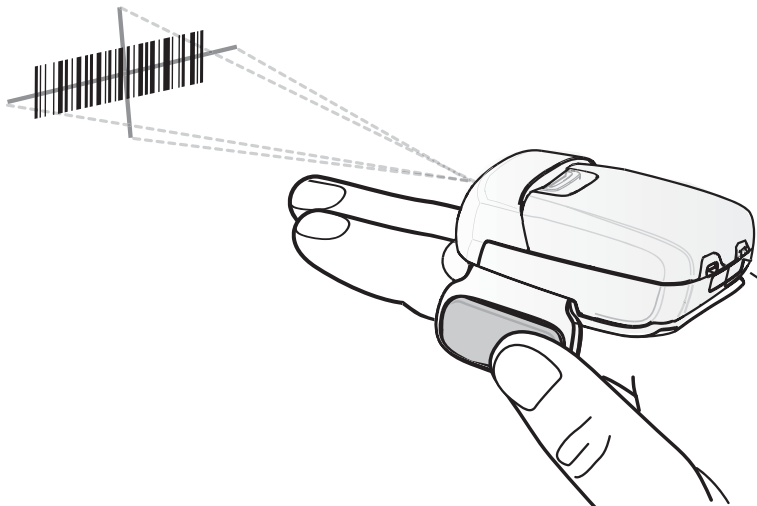
Figure 64 Bar Code Scanning with RS507

3. Press and hold the trigger.

The red laser aiming pattern turns on to assist in aiming. Ensure the bar code is within the area formed by the cross-hairs in the aiming pattern. The aiming dot is used for increased visibility in bright lighting conditions.

The RS507 LEDs light green, a beep sounds to indicate the bar code was decoded successfully. Note that when the RS507 is in Pick List Mode, the RS507 does not decode the bar code until the center of the crosshair touches the bar code.

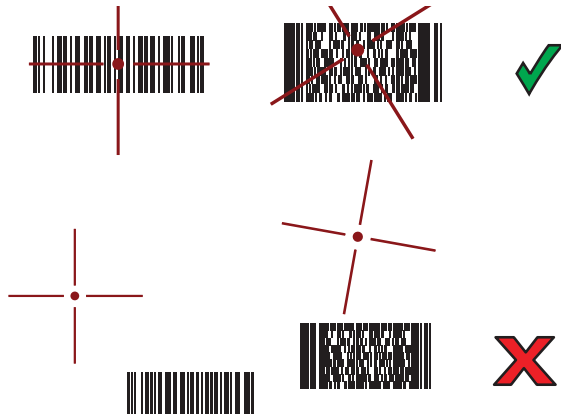
Figure 65 Aiming Pattern**Figure 66** Pick List Mode with Multiple Bar Codes in Aiming Pattern

4. The captured data appears in the text field.

Bar Code Capture Using RS6000 Bluetooth Scanner

To read a barcode, a scan-enabled application is required. The ET5X contains the DataWedge application that allows the user to enable the scanner to decode barcode data and display the barcode content. See [DataWedge Demonstration on page 56](#) for more information on launching DataWedge.

Pair the RS6000 with the ET5X. See [Pairing the RS507/RS6000 Using SSI on page 104](#) or [Pairing the RS507/RS6000 Using HID on page 104](#) for more information.

1. Ensure that an application is open on the device and a text field is in focus (text cursor in text field).
2. Point the RS6000 at a barcode.

Figure 67 Barcode Scanning with RS6000

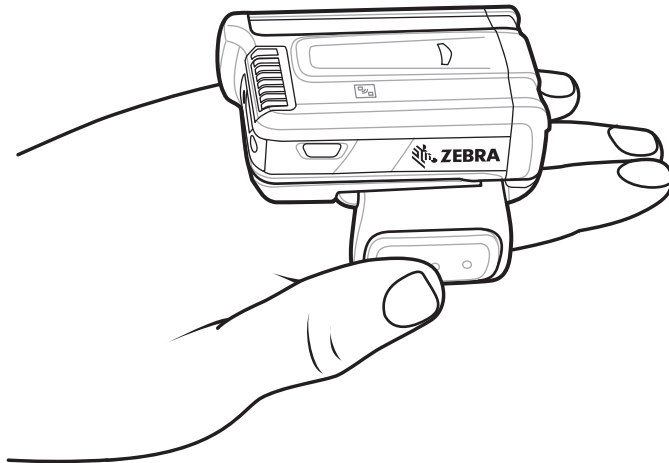

3. Press and hold the trigger.

The red laser aiming pattern turns on to assist in aiming. Ensure the barcode is within the area formed by the cross-hairs in the aiming pattern. The aiming dot is used for increased visibility in bright lighting conditions.

The RS6000 LEDs light green, a beep sounds to indicate the barcode was decoded successfully. Note that when the RS6000 is in Pick List Mode, the RS6000 does not decode the barcode until the center of the cross-hair touches the barcode.

Figure 68 Aiming Pattern

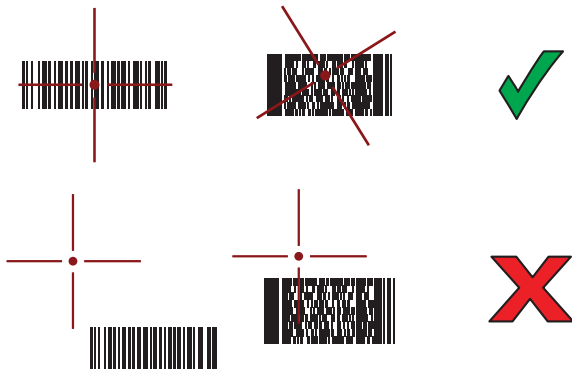

Figure 69 Pick List Mode with Multiple barcodes in Aiming Pattern



4. The captured data appears in the text field.

Bar Code Capture with DS36X8 Scanner

To capture barcodes data:

1. Ensure that an application is open on the device and a text field is in focus (text cursor in text field).
2. Point the scanner at a bar code.

Figure 70 Bar Code Scanning (DS3678-SR shown)

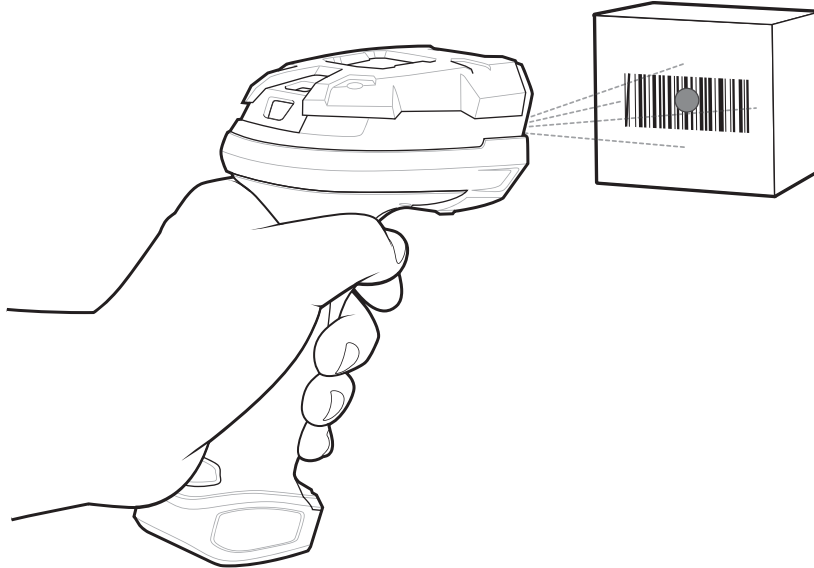

1. Press and hold the trigger.
2. Ensure the bar code is within the area formed by the aiming pattern. The aiming dot is used for increased visibility in bright lighting conditions. The aiming dot is used for increased visibility in bright lighting conditions.

Figure 71 DS3678-SR Aiming Pattern

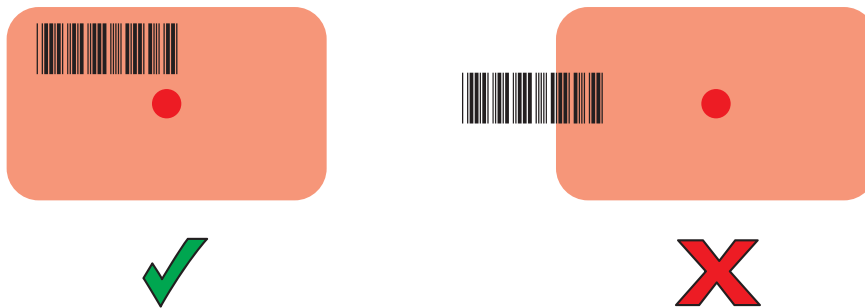
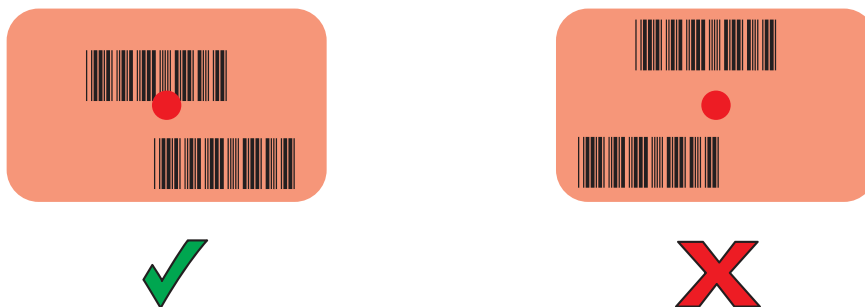

Figure 72 DS3678-SR Pick List Mode with Multiple Bar Codes in Aiming Pattern



4. The captured data appears in the text field.

Pairing the RS507/RS6000 Using SSI

An RS507/RS6000 can be used with the device to capture bar code data.





1. Ensure that the two devices are within 10 meters (32.8 feet) of one another.
2. Install the battery into the RS507/RS6000.
3. On the ET5x touch .
4. Touch .

Figure 73 Bluetooth Pairing Utility

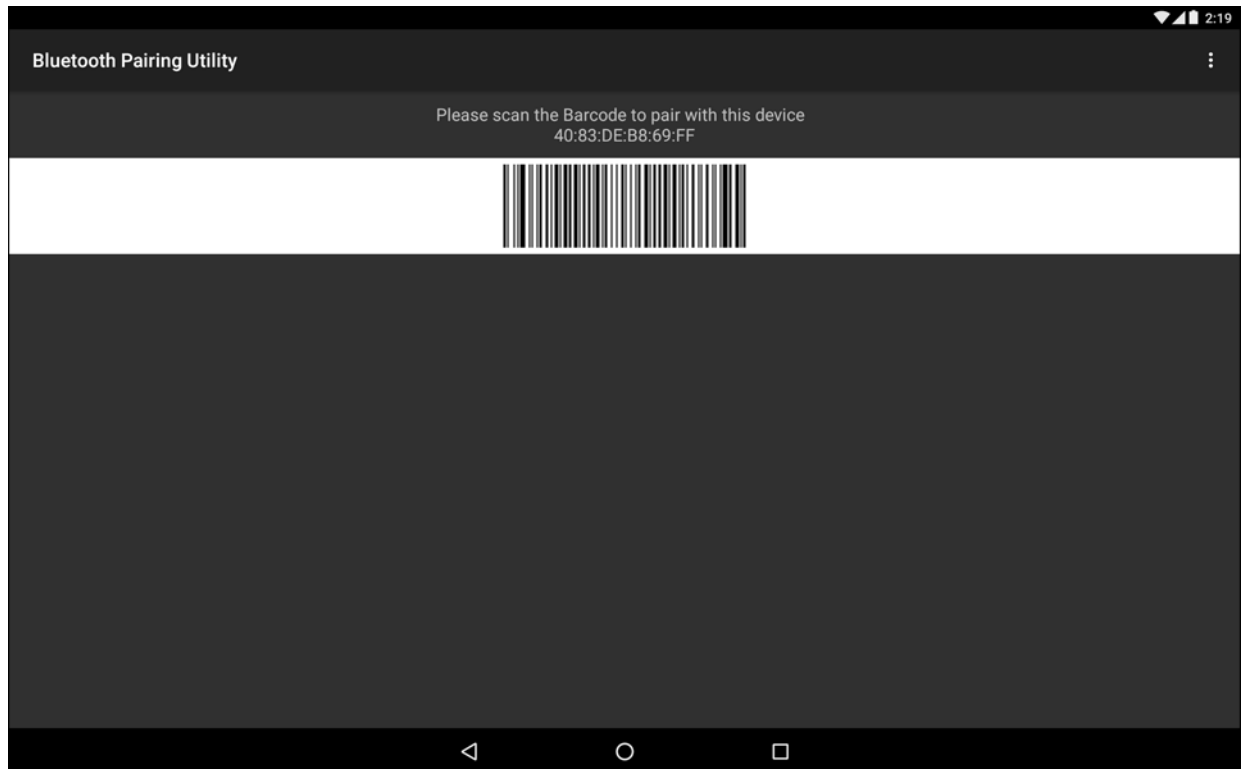

5. Using the RS507/RS6000, scan the bar code on the screen.
The RS507/RS6000 emits a high/low/high/low beeps. The Scan LED flashes green indicating that the RS507/RS6000 is attempting to establish connection with the ET5x. When connection is established, the Scan LED turns off and the RS507/RS6000 emits one string of low/high beeps.
6. On the ET5x touch .

Pairing the RS507/RS6000 Using HID



An RS507/RS6000 can be used with the device to capture bar code data.

1. Ensure that Bluetooth is enabled on both devices.
2. Ensure that the Bluetooth device to discover is in discoverable mode.
3. Ensure that the two devices are within 10 meters (32.8 feet) of one another.
4. Place the RS507/RS6000 in Human Interface Device (HID) mode. If the RS507/RS6000 is already in HID mode, skip to step 5.

- a. Remove the battery from the RS507/RS6000.
- b. Press and hold the Restore key.
- c. Install the battery onto the RS507/RS6000.
- d. Keep holding the Restore key for about five seconds until a chirp is heard and the Scan LEDs flash green.
- e. Scan the bar code below to place the RS507/RS6000 in HID mode.

Figure 74 RS507/RS6000 Bluetooth HID Bar Code



5. Remove the battery from the RS507/RS6000.
6. Re-install the battery into the RS507/RS6000.
7. On the ET5x touch .
8. Touch .
9. Touch  **Bluetooth**.
10. Touch **SCAN FOR DEVICES**. The device begins searching for discoverable Bluetooth devices in the area and displays them under **AVAILABLE DEVICES**.
11. Scroll through the list and select RS507/RS6000.

The device connects to the RS507/RS6000 and **Connected** appears below the device name. The Bluetooth device is added to the **Bluetooth devices** list and a trusted ("paired") connection is established.



Connecting a DS3608 USB Scanner

To connect a DS3608 USB scanner, use one of the following methods:

- Simple Serial Interface (SSI) mode
- Human Interface Device (HID) mode.

Connecting Using Simple Serial Interface

To connect a USB scanner using SSI mode:

1. Connect the scanner cable USB connector to the USB port of a vehicle cradle. The scanner beeps.
2. Ensure that the scanner is in SSI mode. Refer to the Refer to the DS36X8 Product Reference Guide and scan the SSI Over USB CDC barcode.
3. On the ET5X home screen, touch  > .
4. Select a profile.
5. Configure additional settings.

Connecting Using HID Mode

To connect a USB scanner using HID mode:

1. Connect the scanner cable USB connector to the USB port of a vehicle cradle. The scanner beeps.

2. Ensure that the scanner is in HID mode. Refer to the Refer to the DS36X8 Product Reference Guide and scan the HID Keyboard barcode or perform a factory reset.

Pairing a DS3678 Bluetooth Scanner

To connect an DS3678 scanner to the ET5X, use one of the following methods:

- Simple Serial Interface (SSI) mode
- Bluetooth Human Interface Device (HID) mode.

Pairing Using Simple Serial Interface

To pair the DS3678 scanner with the ET5X using SSI:

1. Ensure that the scanner is in SSI mode. Refer to the DS36X8 Product Reference Guide and scan the SSI Over USB CDC barcode.
2. Ensure that the two devices are within 10 meters (32.8 feet) of one another.
3. On the ET5X, swipe up from the bottom of the Home screen and touch .

Figure 75 Bluetooth Pairing Utility

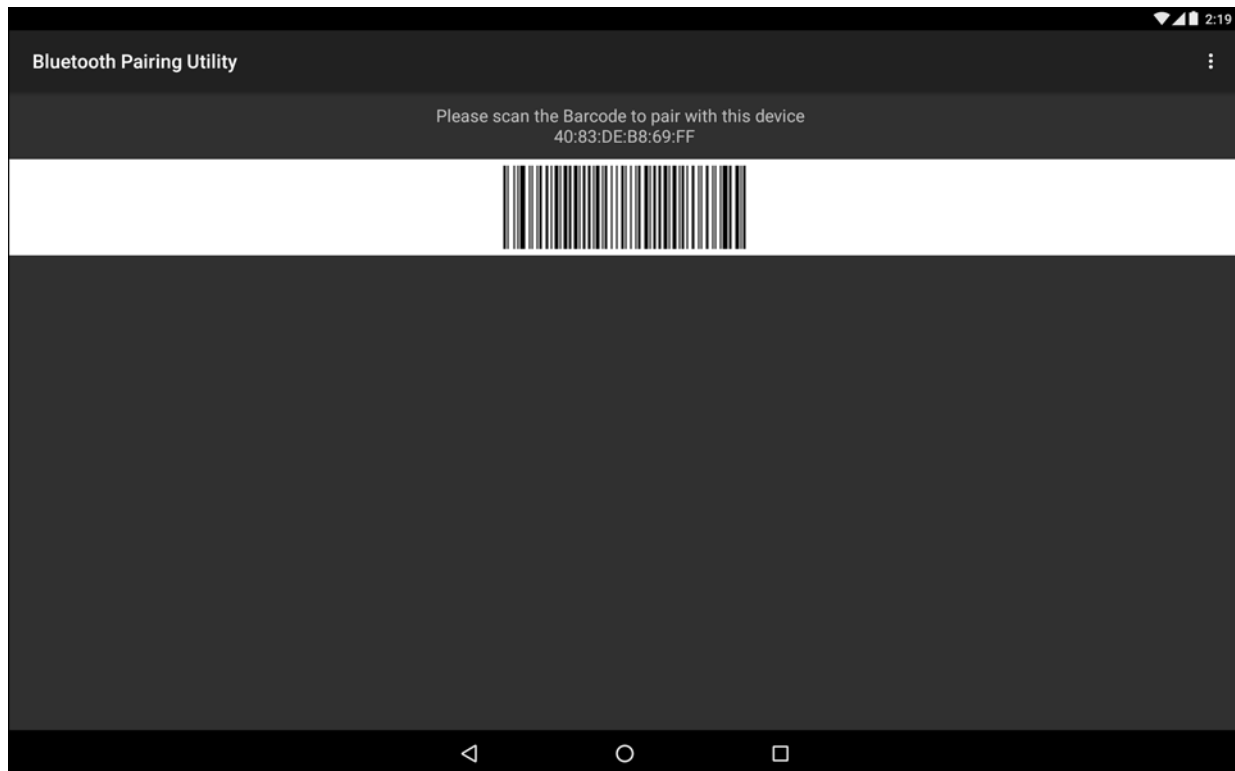

4. Using the scanner, scan the barcode on the screen.
The scanner emits a high/low/high/low beeps. The Scan LED flashes green indicating that the scanner is attempting to establish connection with the ET5X. When connection is established, the Scan LED turns off and the scanner emits one string of low/high beeps.
5. On the ET5X, touch .

Pairing a DS3678 Scanner Using Human Interface Device

To pair the scanner with the ET5X using HID:

1. Ensure that the scanner is in HID mode. Refer to the DS36X8 Product Reference Guide and scan the HID Keyboard barcode.
2. Ensure that the two devices are within 10 meters (32.8 feet) of one another.
3. Touch .
4. Touch **Bluetooth**.
5. The device begins searching for discoverable Bluetooth devices in the area and displays them under **AVAILABLE DEVICES**.
6. Scroll through the list and select the scanner.

The device connects to the scanner and Connected appears below the device name. The Bluetooth device is added to the **Paired devices** list and a trusted (“paired”) connection is established.

Accessories

Introduction

The ET5X accessories provide a variety of product support capabilities. [Table 10](#) lists the accessories available.

Table 10 ET5X Accessories

Accessory	Part Number	Description
Cradles		
Charge Only Cradle	CRD-ET5X-1SCG1	Charges the ET5X main battery and optional Power Pack installed in the Expansion Back. Requires power supply PWR-BGA12V50W0WW, DC Line Cord CBL-DC-388A1-01 and country-specific AC line cord.
Communication and Charging Cradle	CRD-ET5X-1SCOM1	Charges the ET5X main battery and optional Power Pack installed in the Expansion Back. Requires power supply PWR-BGA12V50W0WW, DC Line Cord CBL-DC-388A1-01 and country-specific AC line cord.
Rugged Communication and Charging Cradle	CRD-ET5X-1SCOM1R	Charges the ET5X main battery and optional Power Pack installed in the Expansion Back. Supports ET5X with rugged frame and rugged IO Adapter. Requires power supply PWR-BGA12V50W0WW, DC Line Cord CBL-DC-388A1-01 and country-specific AC line cord.
4-Slot Charge Only Cradle	CRD-ET5X-SE4CO1-01	Charges up to four ET5X main battery and optional Power Pack installed in the Expansion Back and up to four Power Pack in the optional 4-Slot Battery Charger. Requires power supply PWR-BGA12V108W0WW, DC line cord CBL-DC-378A1-01 and country-specific AC line cord.
Chargers		
Power Supply	PWR-BGA12V108W0WW	Provides power to the 4-Slot Charge Only Cradle.

Table 10 ET5X Accessories

Accessory	Part Number	Description
Power Supply	PWR-BGA12V50W0WW	Provides power to the Charge Only Cradle, the Communication and Charging Cradles, the 4-Slot Battery Charger, and the Rugged Charge Connector.
4-Slot Battery Charger	SAC-ET5X-4PPK1-01	Chargers up to four Power Packs. Requires power supply PWR-BGA12V50W0WW, DC Line cord CBL-DC-388A1-01, and country-specific AC line cord.
Rugged Charge Connector	CHG-ET5X-CBL1-01	Charges the ET5X main battery and optional Power Pack installed in the Expansion Back. Requires power supply PWR-BGA12V50W0WW, DC Line Cord CBL-DC-388A1-01 and country-specific AC line cord.
Miscellaneous		
Replacement 8" Internal Battery	BTRY-ET5X-8IN1-01	Replacement battery for 8" tablet.
Replacement 10" Internal Battery	BTRY-ET5X-10IN1-01	Replacement battery for 10" tablet.
Replacement 8" Battery Cover	KT-ET5X-8BTDR1-01	Replacement battery cover for 8" tablet.
Replacement 10" Battery Cover	KT-ET5X-10BTDR1-01	Replacement battery cover for 10" tablet.
8" Rugged Frame with IO Adapter	SG-ET5X-8RCSE1-02	Add extra protection for the 8" tablet and IO Adapter for connection to the Rugged Communication and Charging Cradle.
10" Rugged Frame with IO Adapter	SG-ET5X-10RCSE1-01	Add extra protection for the 10" tablet and IO Adapter for connection to the Rugged Communication and Charging Cradle.
Replacement Rugged IO Connector	SG-ET5X-RGIO1-01	Replacement rugged IO connector for the Rugged Frames.
8" SE4750 Expansion Back	ZBK-ET5X-8SCN5-02	Provides data capture using the SE4750 scan engine, rotating hand strap and slot for optional Power Pack.
8" Expansion Back	ZBK-ET5X-8RH1-01	Provides rotating hand strap and slot for optional Power Pack.
10" SE4750 Expansion Back	ZBK-ET5X-10SCN5-02	Provides data capture using the SE4750 scan engine, rotating hand strap and slot for optional Power Pack.
10" Expansion Back	ZBK-ET5X-10RH1-01	Provides rotating hand strap and slot for optional Power Pack.
Power Pack	BTRY-ET5X-PRPK1-01	Provides additional power for charging the ET5X battery using an Expansion Back.

Table 10 ET5X Accessories

Accessory	Part Number	Description
Active Stylus	KT-ET5X-ASTY2-01	Provides easy writing, drawing, and navigation and accuracy with the thin tip and hovering capabilities.
Replacement Expansion Back Hand Strap	SG-ET5X-RHTP1-01	Replacement hands strap for Expansion Backs.
Coiled Stylus Tether	SG-ET5X-SLTETR-01	Secures a stylus to the hand strap on the Expansion Backs.
10" Screen Protector	KT-ET5X-10SCRN1-01	Provides additional screen protection for 10" tablet (5-pack).
8" Screen Protector	KT-ET5X-8SCRN1-01	Provides additional screen protection for 8" tablet (5-pack).
10" Screen Protector (Rugged Frame)	KT-ET5X-8SCRN1-01	Provides additional screen protection for 10" tablet with Rugged Frame (5-pack).
8" Screen Protector (Rugged Frame)	KT-ET5X-10SCRN1-02	Provides additional screen protection for 8" tablet with Rugged Frame (5-pack).
8" Operations Case	SG-ET5X-8HLST-01	Provides carrying solution for 8" tablet.
10" Operations Case	SG-ET5X-10HLST-01	Provides carrying solution for 10" tablet.
Universal Shoulder Strap	58-40000-007R	Use with the 8" Operations Case and D-clips to carry tablet on shoulder.

Charge Only Cradle



CAUTION Ensure that you follow the guidelines for battery safety described in [Battery Safety Guidelines on page 132](#).



NOTE The Charge Only Cradle (CRD-ET5X-1SCG1) comes with two inserts; tall insert and short insert. Install the tall insert when using an ET5X without a Rugged Frame or Expansion Back. Install the small insert when using an ET5X with an Expansion Back and without a Rugged Frame.

This section describes how to use a Charge Only Cradle with the ET5X.

The Charge Only Cradle:

- Provides power for operating the ET5X.
- Charges the ET5X's battery and optional Power Pack installed in an Expansion Back.

Figure 76 Charge Only Cradle - Front View

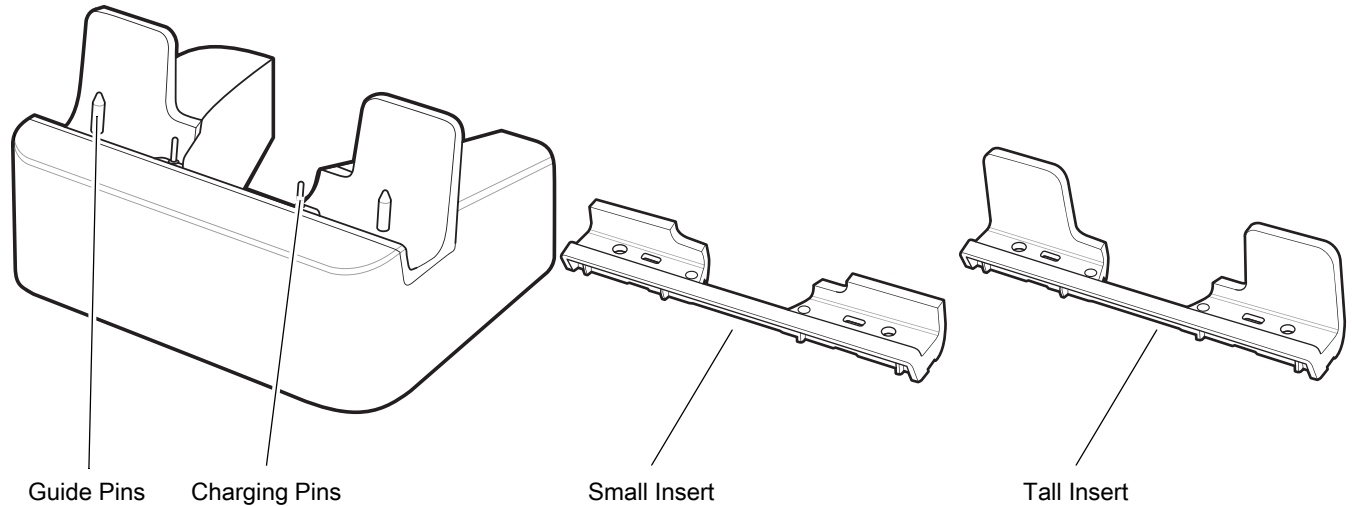
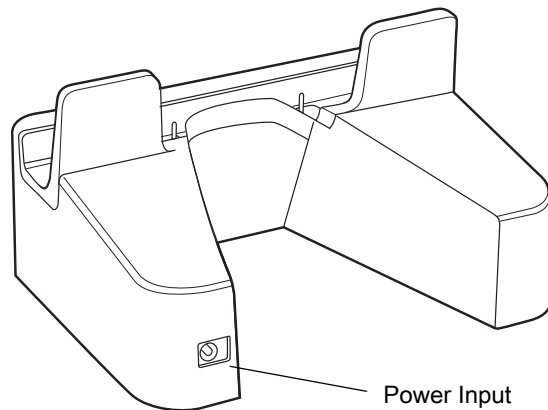

Figure 77 Charge Only Cradle - Rear View



Installing the Insert

Install the tall insert when using an ET5X without a Rugged Frame or Expansion Back. Install the small insert when using an ET5X with an Expansion Back and without a Rugged Frame.

1. Align the insert over the pins.

Figure 78 Align Insert with Cradle

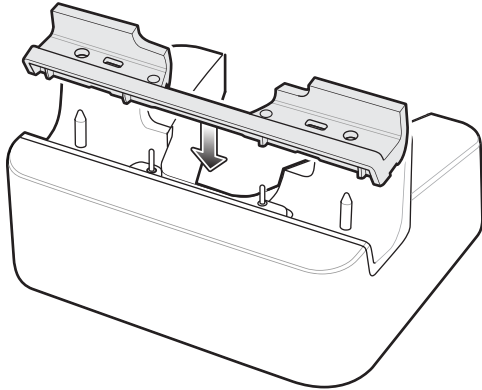

2. Press the insert down until it seats flush in the cradle.

Charging the ET5X

To charge the ET5X in the Charge Only Cradle:

1. Align the ET5X with the alignment pins on the cradle.
2. Insert the ET5X into the cradle.

Figure 79 Insert ET5X into Charge Only Cradle

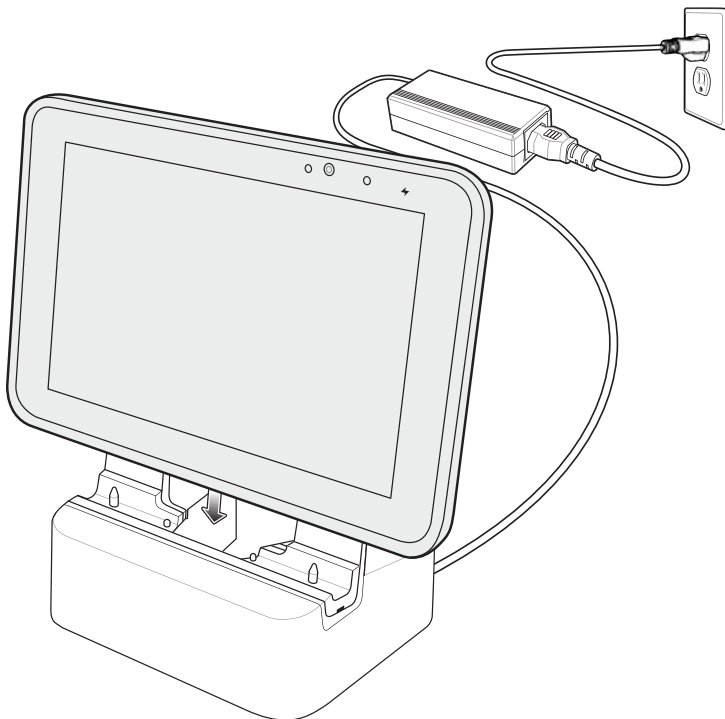

3. The ET5X Charging LED indicates charging.
4. To remove the ET5X from the Charge Only Cradle, hold the cradle down with one hand and lift the ET5X.

Figure 80 Remove ET5X from Charge Only Cradle

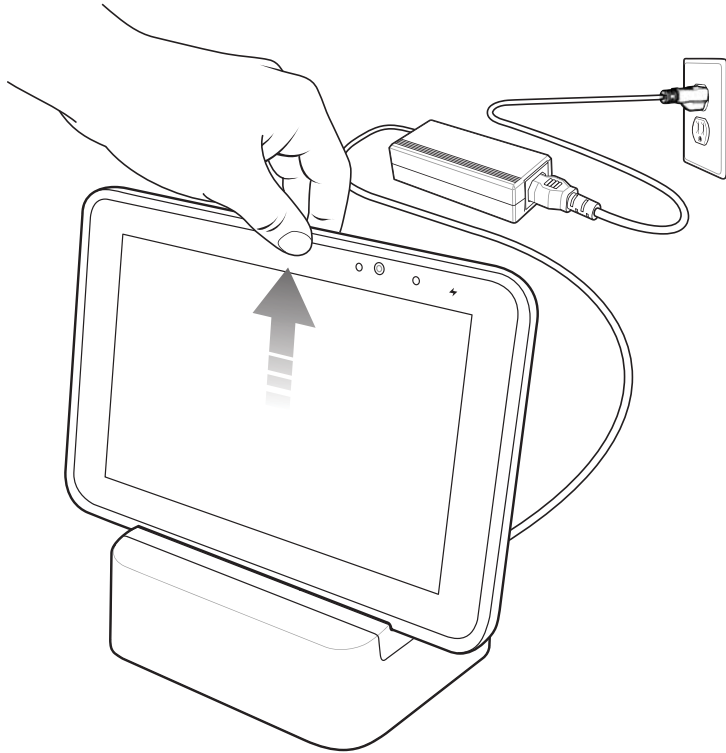

Charge batteries in ambient temperatures from 0°C to 40°C (32°F to 104°F) as reported by the battery. Charging is intelligently controlled by the charger. To accomplish this, for small periods of time, the charger alternately enables and disables battery charging to keep the battery at acceptable temperatures.

The ET5X's amber charge LED shows the status of the battery charging in the ET5X. See [Charging Indicator on page 21](#) for charging status indications.

The 8" tablet main battery charges from fully depleted to 90% in approximately 2.5 hours and from fully depleted to 100% in approximately 3.5 hours.

The 10" tablet main battery charges from fully depleted to 90% in approximately three hours and from fully depleted to 100% in approximately four hours.

✓ **NOTE** The Charging indicator only illuminates when the ET5X is connected to AC power.

Table 11 Charging Indicator

LED	Indication
Off	ET5X is not in cradle. ET5X is not seated properly. Cradle is not powered.
Orange	ET5X is charging.
Green	Charging complete.
Red	Error in charging; check placement of the ET5X.

Communication and Charging Cradle



CAUTION Ensure that you follow the guidelines for battery safety described in [Battery Safety Guidelines on page 132](#).



NOTE The Communication and Charging Cradle (CRD-ET5X-1SCOM1) comes with two inserts; tall insert and short insert. Install the tall insert when using an ET5X without a Rugged Frame or Expansion Back. Install the small insert when using an ET5X with an Expansion Back and without a Rugged Frame.

This section describes how to use a Communication and Charging Cradle with the ET5X.

The Communication and Charging cradle:

- Provides power for operating the ET5X.
- Provides ports for connecting USB devices to the tablet, video output and connection to a LAN.
- Charges the ET5X's battery and optional Power Pack installed in an Expansion Back.

Figure 81 Communication and Charging Cradle - Front View

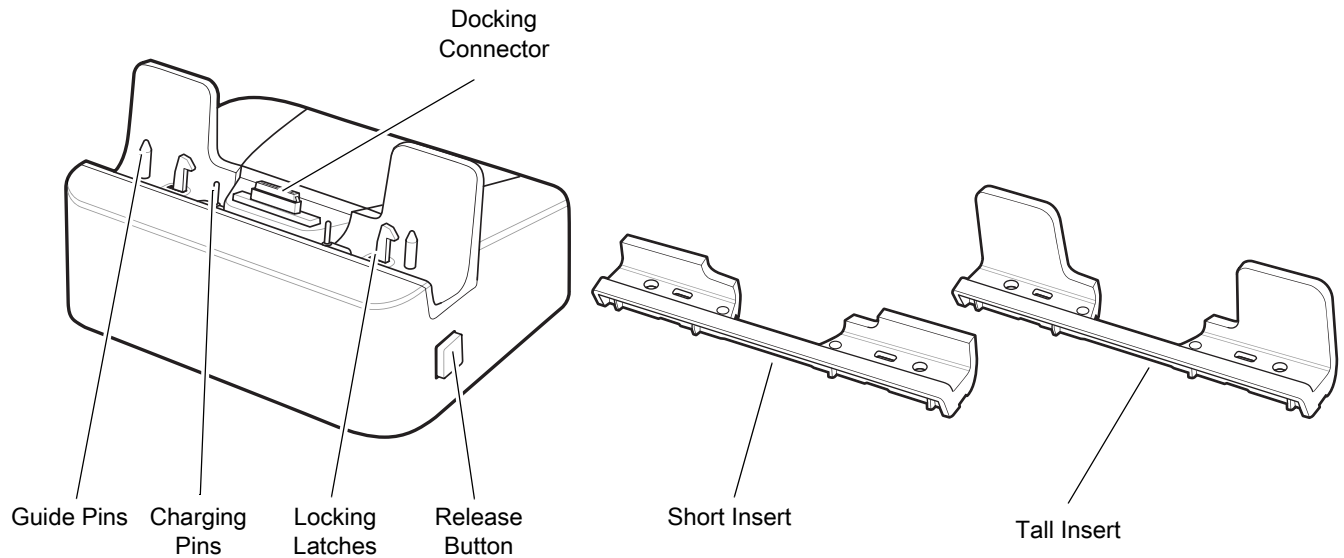

Figure 82 Communication and Charging Cradle - Rear View

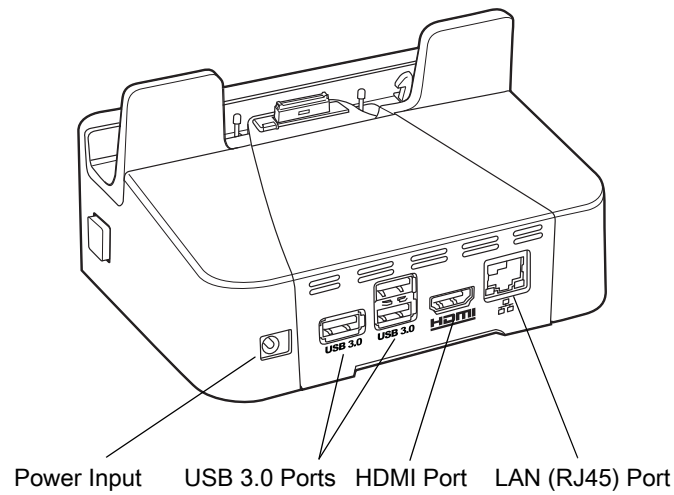
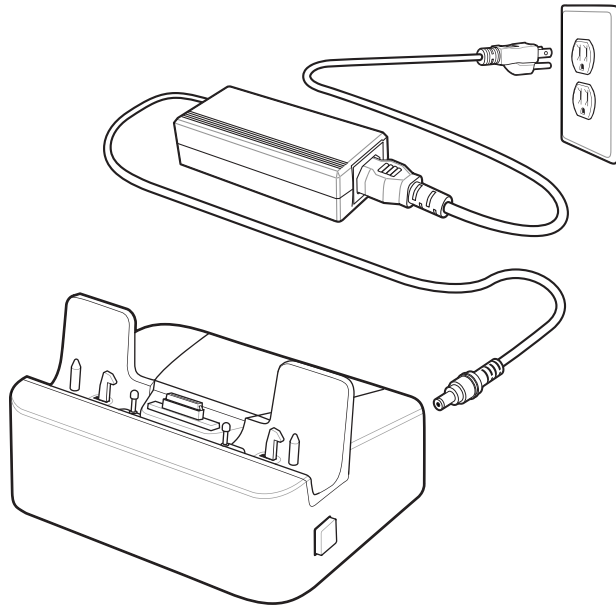

Figure 83 Communication and Charging Cradle - Setup



Installing the Insert

Install the tall insert when using an ET5X without an Expansion Back. Install the small insert when using an ET5X with an Expansion Back.

1. Align the insert over the pins.

Figure 84 Align Insert with Cradle

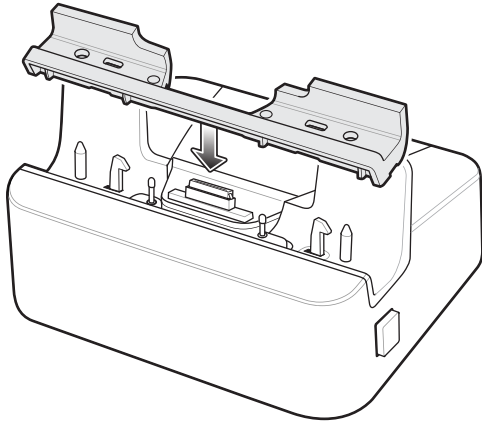

2. Press the insert down until it seats flush in the cradle.

Charging the ET5X

To charge the ET5X in the Communication and Charging Cradle:

1. Open the bottom access door and hold it to the back of the tablet.
2. Align the ET5X with the alignment pins on the cradle.
3. Insert the ET5X into the cradle. Note that the Communication and Charging Cradles contains a locking mechanism that locks the ET5X to the cradle.

Figure 85 Insert ET5X into Communication and Charging Cradle

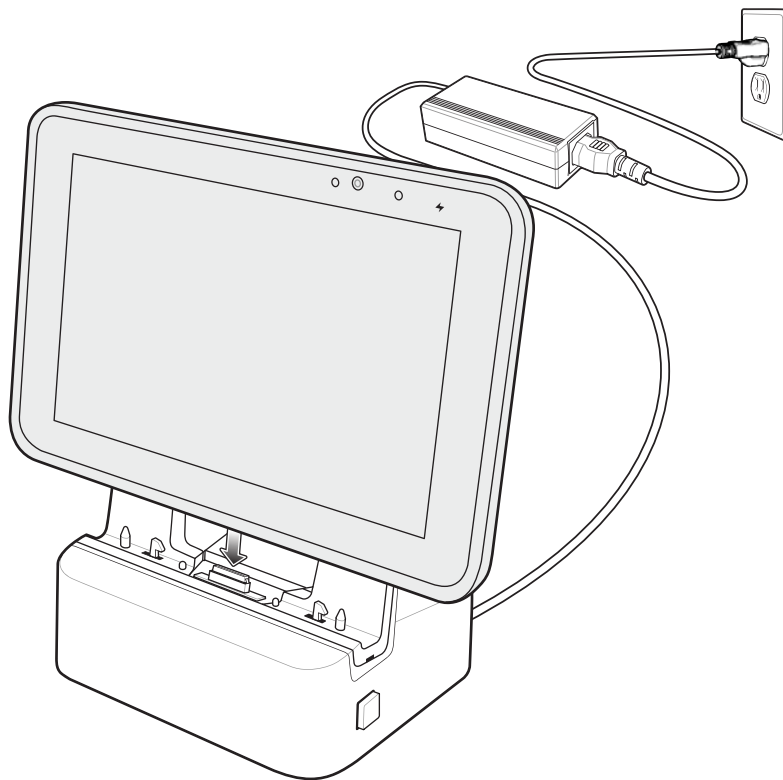

4. The ET5X Charging LED indicates charging.

5. To remove the ET5X from the Communication and Charging Cradle, press the release button on the right side of the cradle and lift the ET5X. Use thumb to hold down the cradle.

Figure 86 Remove ET5X from Communication and Charging Cradles

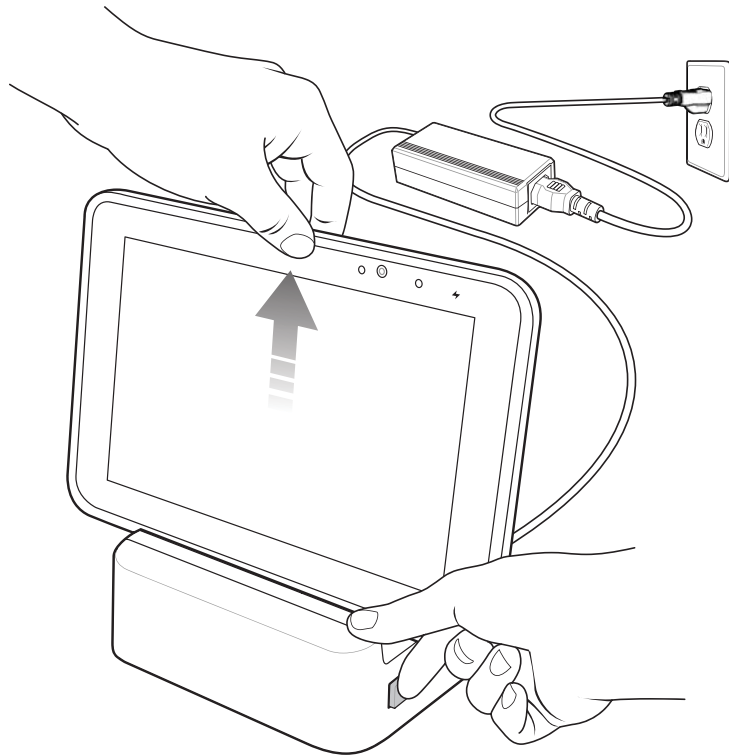

Charge batteries in ambient temperatures from 0°C to 40°C (32°F to 104°F) as reported by the battery. Charging is intelligently controlled by the charger. To accomplish this, for small periods of time, the charger alternately enables and disables battery charging to keep the battery at acceptable temperatures.

The ET5X's amber charge LED shows the status of the battery charging in the ET5X. See [Charging Indicator on page 21](#) for charging status indications.

The 8" tablet main battery charges from fully depleted to 90% in approximately 2.5 hours and from fully depleted to 100% in approximately 3.5 hours.

The 10" tablet main battery charges from fully depleted to 90% in approximately three hours and from fully depleted to 100% in approximately four hours.

Rugged Communication and Charging Cradle



CAUTION Ensure that you follow the guidelines for battery safety described in [Battery Safety Guidelines on page 132](#).

This section describes how to use a Rugged Communication and Charging Cradle with the ET5X.

The Rugged Communication and Charging cradle:

- Provides power for operating the ET5X.
- Provides ports for connecting USB devices to the tablet, video output and connection to a LAN.
- Charges the ET5X's battery and optional Power Pack installed in an Expansion Back.

Figure 87 Rugged Communication and Charging Cradle - Front View

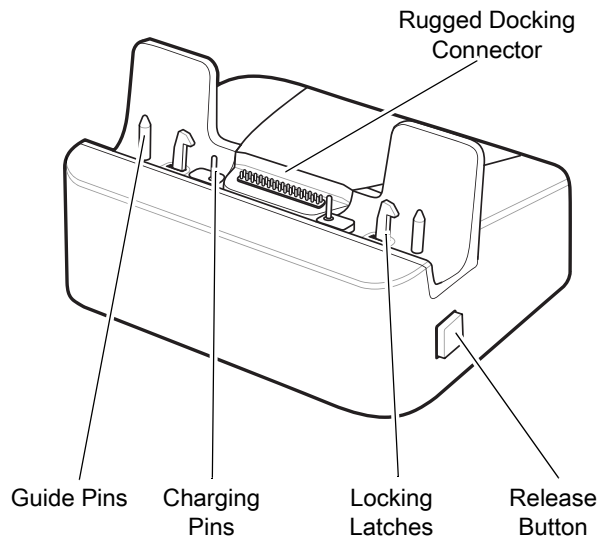

Figure 88 Rugged Communication and Charging Cradle - Rear View

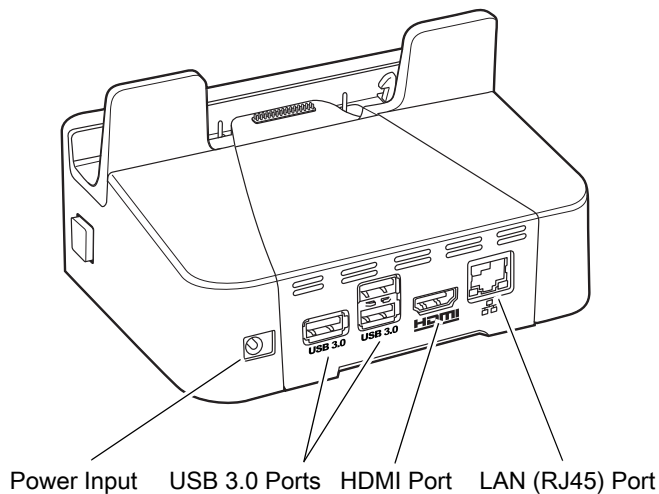
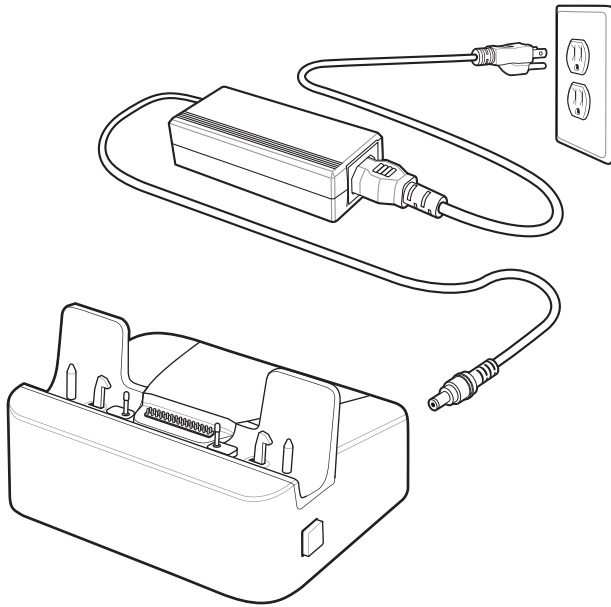

Figure 89 Rugged Communication and Charging Cradle - Setup



Charging the ET5X

To charge the ET5X using the Rugged Communication and Charging Cradle:

1. Align the ET5X with the alignment pins on the cradle.
2. Insert the ET5X into the cradle. Note that the Rugged Communication and Charging Cradles contains a locking mechanism that locks the ET5X to the cradle.

Figure 90 Insert ET5X with Rugged Frame and IO Adapter into Rugged Communication and Charging Cradle

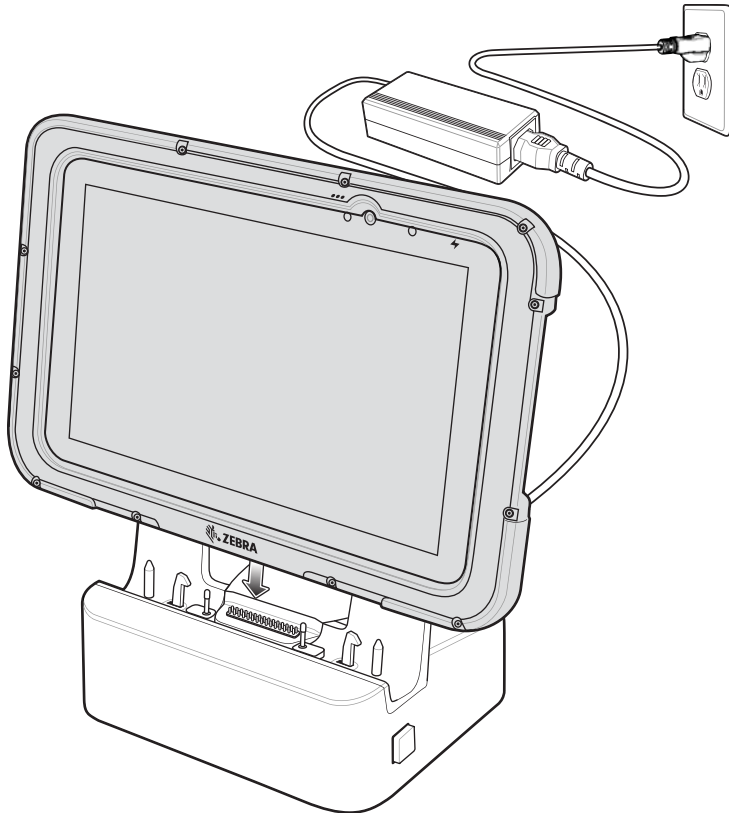

3. The ET5X Charging LED indicates charging.
4. To remove the ET5X from the Rugged Communication and Charging Cradle, press the release button on the right side of the cradle and lift the ET5X. Use thumb to hold down the cradle.

Figure 91 Remove ET5X from Rugged Communication and Charging Cradles

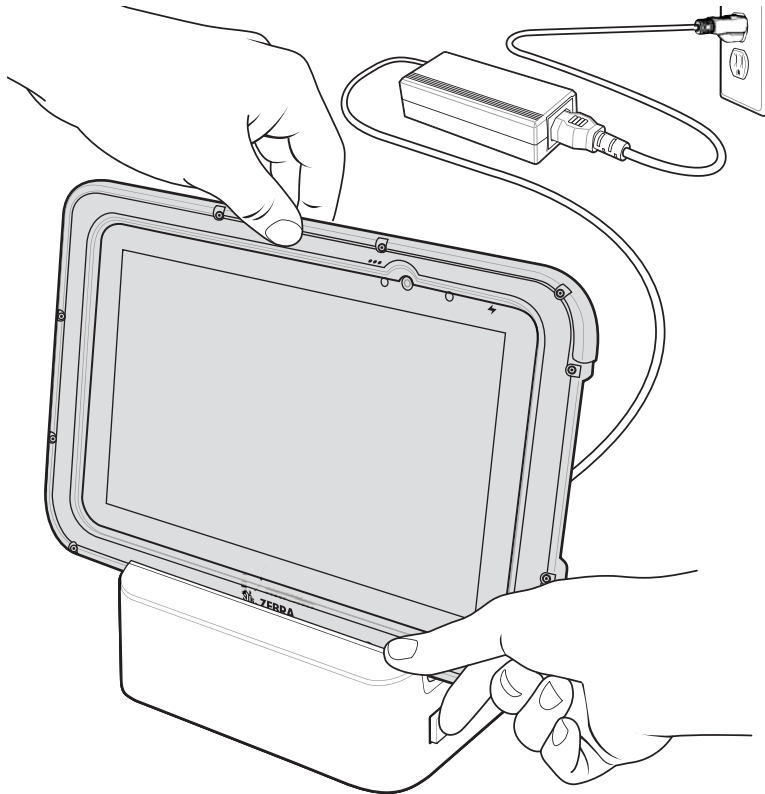

Charge batteries in ambient temperatures from 0°C to 40°C (32°F to 104°F) as reported by the battery. Charging is intelligently controlled by the charger. To accomplish this, for small periods of time, the charger alternately enables and disables battery charging to keep the battery at acceptable temperatures.

The ET5X's amber charge LED shows the status of the battery charging in the ET5X. See [Charging Indicator on page 21](#) for charging status indications.

The 8" tablet main battery charges from fully depleted to 90% in approximately 2.5 hours and from fully depleted to 100% in approximately 3.5 hours.

The 10" tablet main battery charges from fully depleted to 90% in approximately three hours and from fully depleted to 100% in approximately four hours.

4-Slot Charge Only Cradle



CAUTION Ensure that you follow the guidelines for battery safety described in [Battery Safety Guidelines on page 132](#).

- Provides 5 VDC power for operating the ET5X.
- Simultaneously charges up to four ET5Xs and up to four Power Packs using the optional Battery Charger Adapter. See the *ET5X Integrator Guide* for information on installing the 4-Slot Battery Charger onto the cradle.

Figure 92 4-Slot Charge Only Cradle

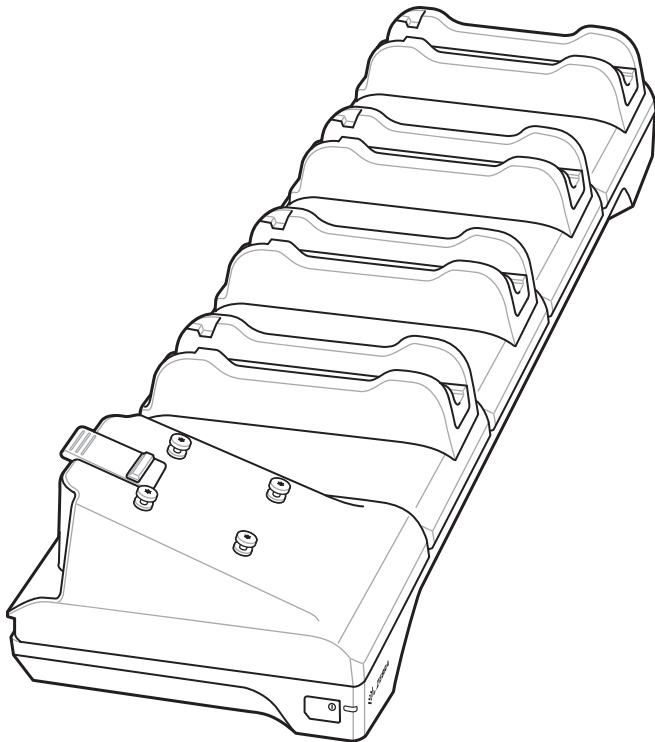

Insert Installation

Install inserts into slots for ET5X tablets without Rugged Frame.

Figure 93 Install Insert in Slot

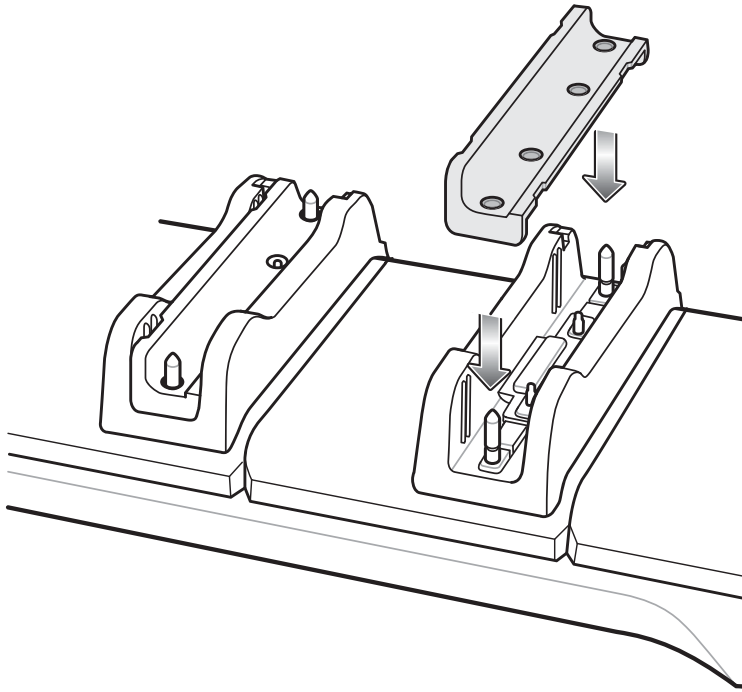

Power Setup

Figure 94 Power Setup with Optional Charger

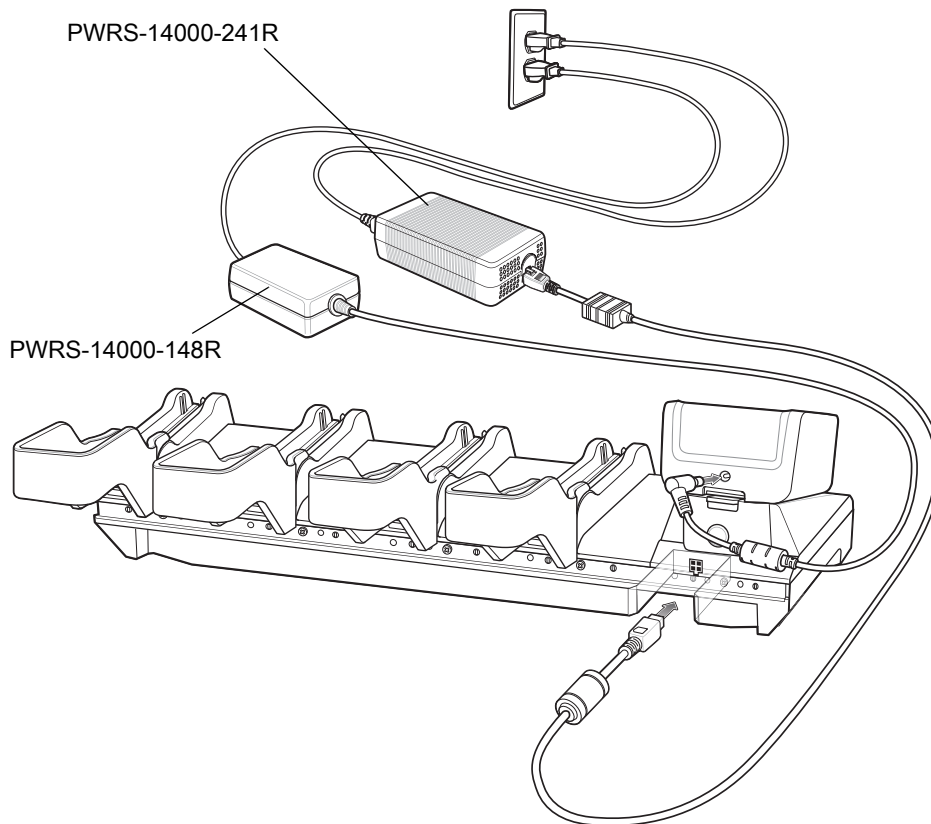

Insert Tablet into Slot

ET5X without Rugged Frame

1. Install insert into slot.
2. Align the two alignment holes on the bottom of the tablet with the two alignment pins in the slot.

Figure 95 Insert ET5X without Rugged Frame into Slot

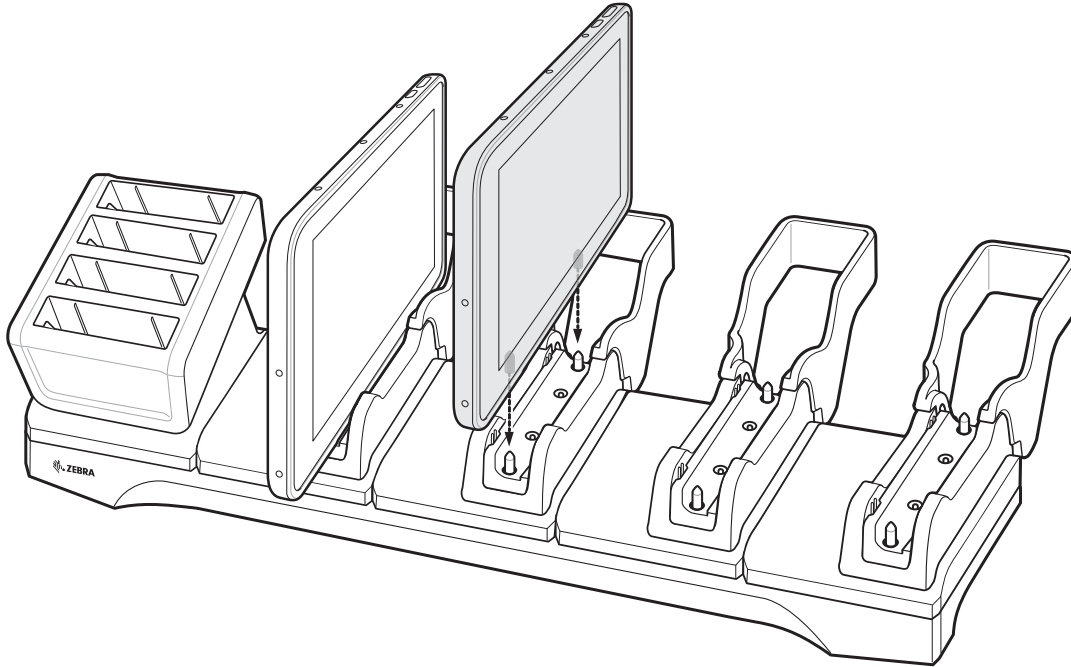

3. Place the ET5X down into the slot with display facing away from Battery Charger.

ET5X with Rugged Frame

1. If applicable, remove insert from slot.
2. Slide ET5X over slot into it touches the guide.

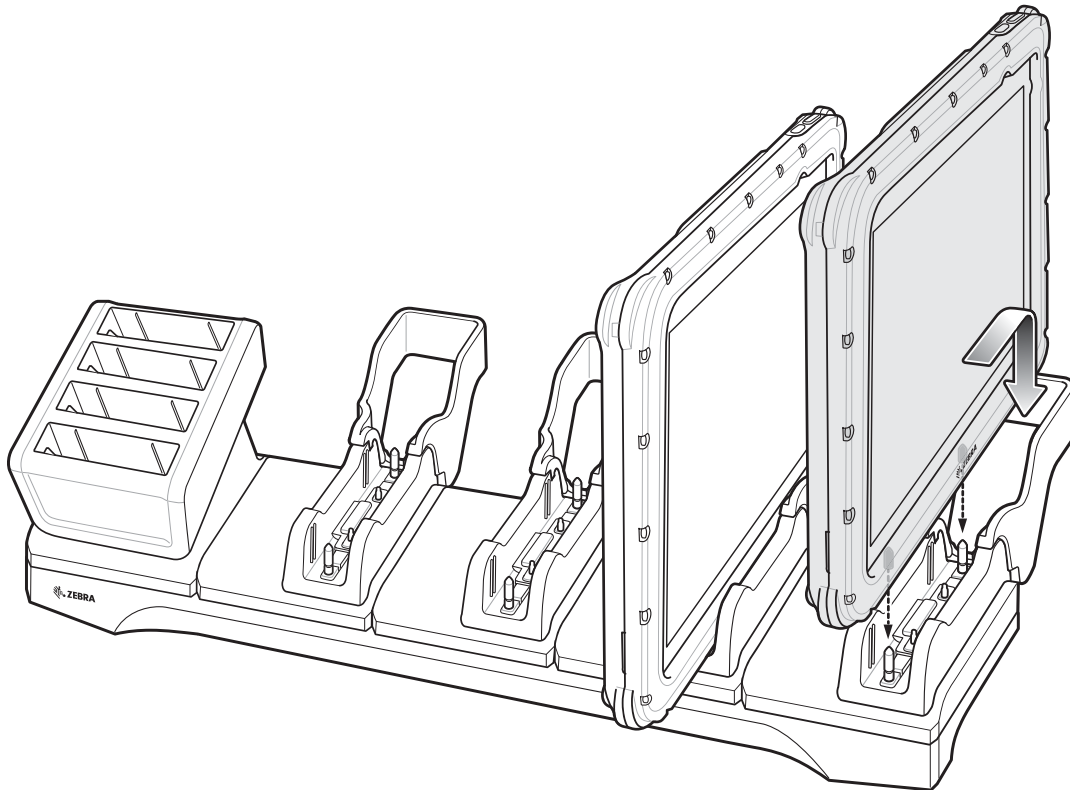
Figure 96 Insert ET5X with Rugged Frame into Slot

3. Place the ET5X down into the slot with display facing away from Battery Charger.

Charging the Battery

Charge batteries in ambient temperatures from 0°C to 40°C (32°F to 104°F) as reported by the battery. Charging is intelligently controlled by the charger. To accomplish this, for small periods of time, the charger alternately enables and disables battery charging to keep the battery at acceptable temperatures.

The ET5X's amber charge LED shows the status of the battery charging in the ET5X. See [Charging Indicator on page 21](#) for charging status indications.

The 8" tablet main battery charges from fully depleted to 90% in approximately 2.5 hours and from fully depleted to 100% in approximately 3.5 hours.

The 10" tablet main battery charges from fully depleted to 90% in approximately three hours and from fully depleted to 100% in approximately four hours.

Rugged Charge Connector



CAUTION Ensure that you follow the guidelines for battery safety described in [Battery Safety Guidelines on page 132](#).

Use the Rugged Charge Connector to charge an ET5X tablet.

Figure 97 Rugged Charge Connector

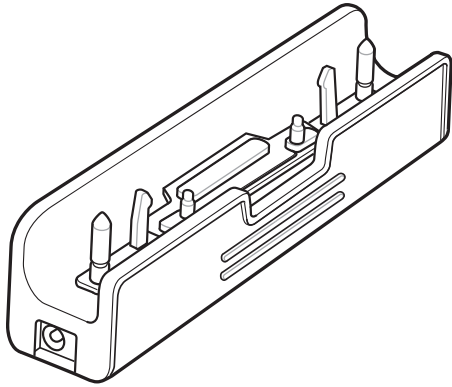

1. Align the pins in the Rugged Charge Connector with the slots in the ET5X.

Figure 98 Insert ET5X into Rugged Charge Connector

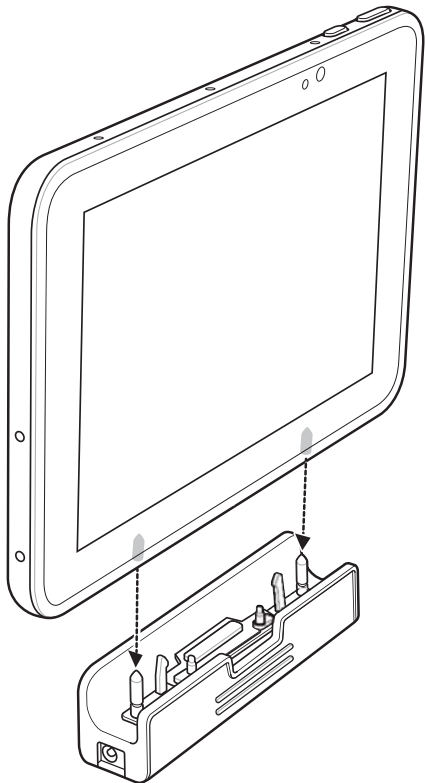

2. Plug the Power Supply connector into the Power Input Port on the Rugged Charge Connector.

Figure 99 Plug Power Supply into Input Power Port

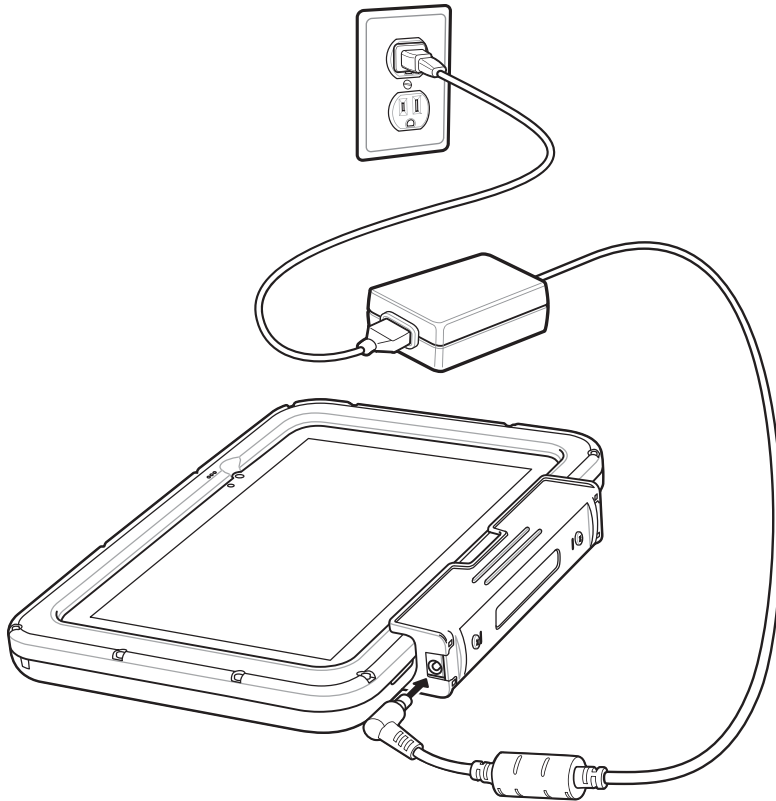

Charge batteries in ambient temperatures from 0°C to 40°C (32°F to 104°F) as reported by the battery. Charging is intelligently controlled by the charger. To accomplish this, for small periods of time, the charger alternately enables and disables battery charging to keep the battery at acceptable temperatures.

The ET5X's amber charge LED shows the status of the battery charging in the ET5X. See [Charging Indicator on page 21](#) for charging status indications.

The 8" tablet main battery charges from fully depleted to 90% in approximately 2.5 hours and from fully depleted to 100% in approximately 3.5 hours.

The 10" tablet main battery charges from fully depleted to 90% in approximately three hours and from fully depleted to 100% in approximately four hours.

Power Pack

The optional Power Pack provides additional power for charging the main battery.

Figure 100 Power Pack

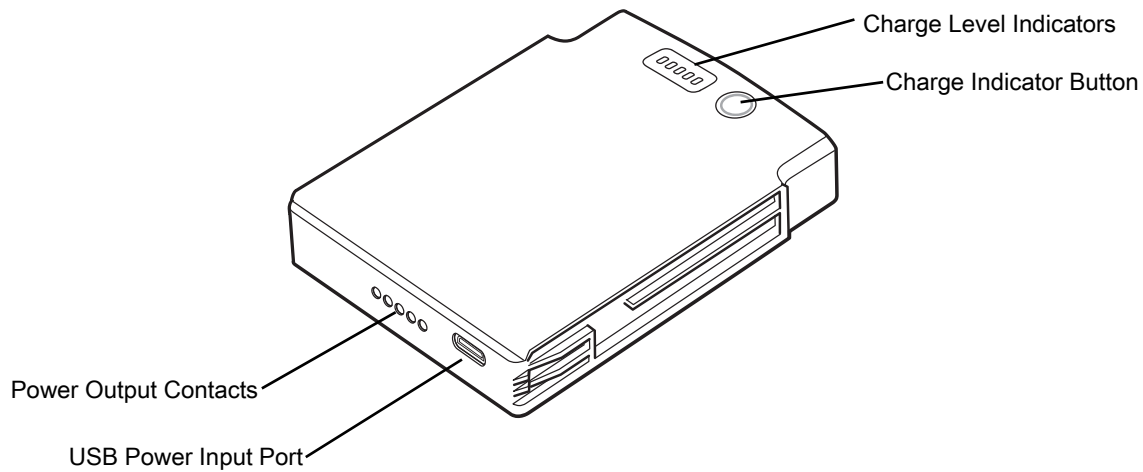

1. Install one of the optional Expansion Backs. See *ET5X Integrator Guide* for more information.
2. Press the two release buttons on the side of the Expansion Back. The dummy battery insert ejects slightly.

Figure 101 Remove Dummy Battery Insert

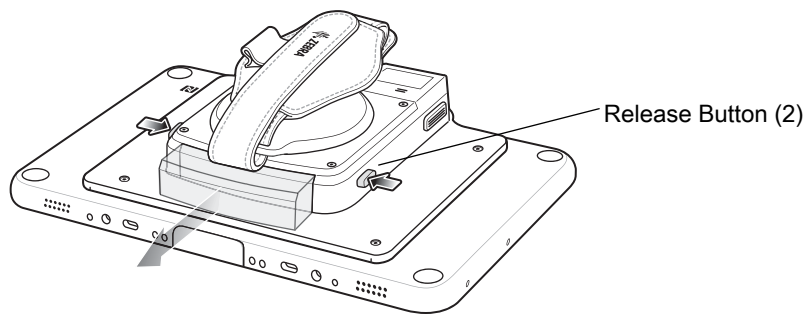

3. Remove dummy battery insert.
4. Insert Power Pack into slot until it snaps into place.

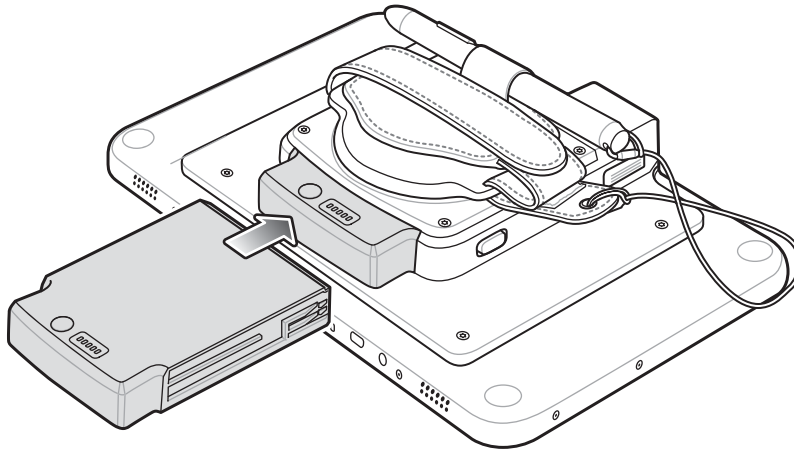
Figure 102 Install Power Pack

Charging the Power Pack

Charge the Power Pack using:

- a cradle
- USB power adapter
- 4-Slot Charger.

Using Cradle

With the Power Pack installed in an Expansion Back, place the ET5X into a cradle. The Power Pack charges in less than 3.5 hours.

Using USB Power Adapter

Charge the Power Pack using a suitable power source that supplies 5 VDC @ 2A. The Power Pack charges in less than five hours.

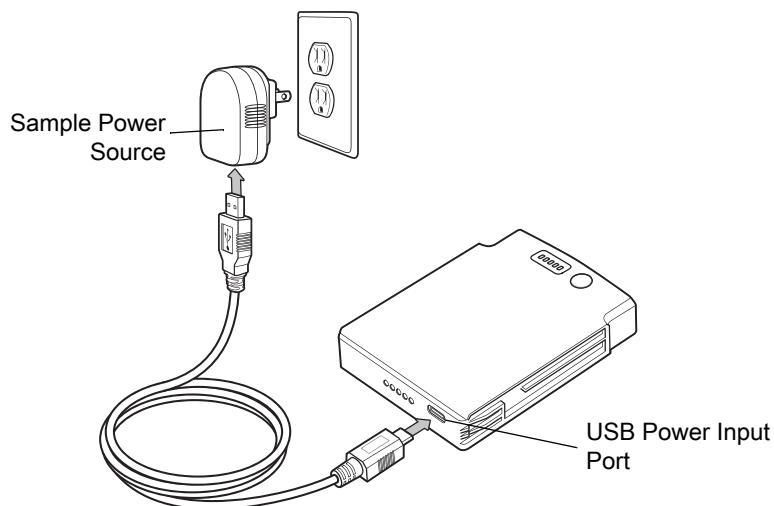
Figure 103 Charging Using Suitable Power Source

Using the 4-Slot Battery Charger



CAUTION Ensure that you follow the guidelines for battery safety described in [Battery Safety Guidelines on page 132](#).

Use the 4-Slot Battery Charger to charge up to four Power Packs.

Figure 104 4-Slot Battery Charger

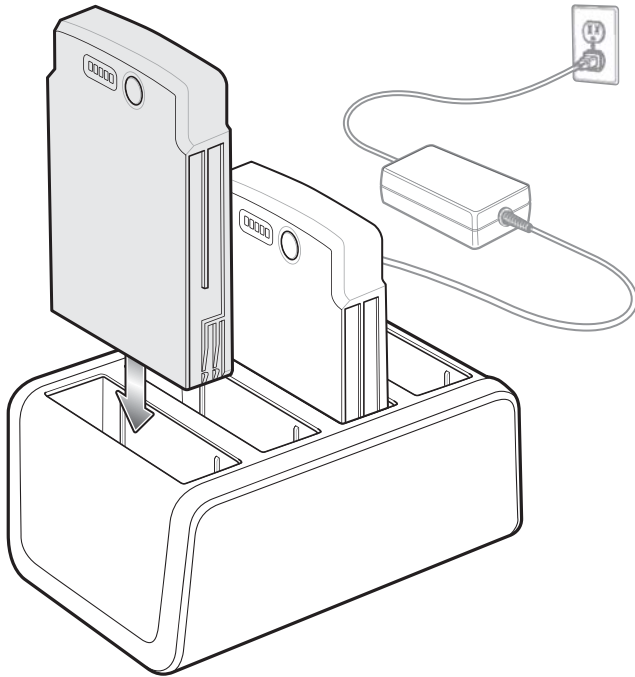

Charging the Power Pack

Charge Power Packs in ambient temperatures from 0°C to 40°C (32°F to 104°F) as reported by the Power Pack. Charging is intelligently controlled by the charger. To accomplish this, for small periods of time, the charger alternately enables and disables Power Pack charging to keep the battery at acceptable temperatures.

The Power Pack charge LED shows the status of the battery charging in the charger. See [Power Pack Charge Status Indicators on page 131](#) for charging status indications.

The Power Pack charges in less than three hours.

When charging, the Charge LEDs indicate the charge level.

Figure 105 Power Pack Charge LEDs

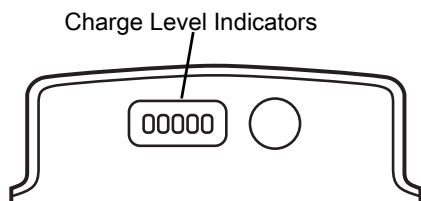













Table 12 Power Pack Charge Status Indicators

Power Pack Indicators	Description
	Power not applied to Power Pack.
	Charge level is between 0% and 20%.
	Charge level is between 20% and 40%.
	Charge level is between 40% and 60%.
	Charge level is between 60% and 80%.
	Charge level is between 80% and 100%.
	Fully charged.
	Charging error.
	Solid Green LED
	Blinking Green LED
	Blinking Red LED

Maintenance and Troubleshooting

Introduction

This chapter includes instructions on cleaning and storing the ET5X, battery maintenance and provides troubleshooting solutions for potential problems during ET5X operations.

Maintaining the ET5X

For trouble-free service, observe the following tips when using the ET5X:

- Protect the ET5X from temperature extremes.
- Do not store or use the ET5X in any location that is extremely dusty, damp, or wet.
- Use a soft lens cloth to clean the screen. If the surface of the ET5X screen becomes soiled, clean it with a soft cloth moistened with a diluted window-cleaning solution. Do not use bleach or ammonia.
- Take care not to scratch the screen of the ET5X.
- The display of the ET5X contains glass. Take care not to drop the ET5X or subject it to strong impact.

Battery Safety Guidelines

- The area in which the ET5X units are charged should be clear of debris and combustible materials or chemicals. Particular care should be taken where the device is charged in a non-commercial environment.
- Do not use incompatible batteries and chargers. If you have any questions about the compatibility of a battery or a charger, contact Zebra Support. See [Service Information on page 11](#) for contact information.
- Do not crush, puncture, or place a high degree of pressure on the battery.
- Follow battery usage, storage, and charging guidelines found in the *ET5X Quick Reference Guide*.
- Improper battery use may result in a fire, explosion, or other hazard.
- To charge the mobile device battery, the battery and charger temperatures must be between +32°F and +104°F (0°C and +40°C)
- Do not disassemble or open, crush, bend or deform, puncture, or shred.
- Severe impact from dropping any battery-operated device on a hard surface could cause the battery to overheat.
- Do not short circuit a battery or allow metallic or conductive objects to contact the battery terminals.
- Do not modify or remanufacture, attempt to insert foreign objects into the battery, immerse or expose to water or other liquids, or expose to fire, explosion, or other hazard.

- Do not leave or store the equipment in or near areas that might get very hot, such as in a parked vehicle or near a radiator or other heat source. Do not place battery into a microwave oven or dryer.
- Battery usage by children should be supervised.
- Please follow local regulations to promptly dispose of used re-chargeable batteries.
- Do not dispose of batteries in fire.
- Seek medical advice immediately if a battery has been swallowed.
- In the event of a battery leak, do not allow the liquid to come in contact with the skin or eyes. If contact has been made, wash the affected area with large amounts of water and seek medical advice.
- If you suspect damage to your equipment or battery, call Customer Support to arrange for inspection. See [Service Information on page 11](#) for contact information.

Cleaning



CAUTION Always wear eye protection.

Read warning label on compressed air and alcohol product before using.

If you have to use any other solution for medical reasons please contact Zebra for more information.



WARNING! Avoid exposing this product to contact with hot oil or other flammable liquids. If such exposure occurs, unplug the device and clean the product immediately in accordance with these guidelines.

Materials Required

- Alcohol wipes
- Lens tissue
- Cotton tipped applicators
- Isopropyl alcohol
- Can of compressed air with a tube.

Cleaning the ET5X

Housing

Using the alcohol wipes, wipe the housing.

Display

The display can be wiped down with the alcohol wipes, but care should be taken not to allow any pooling of liquid around the edges of the display. Immediately dried the display with a soft, non-abrasive cloth to prevent streaking.

Power Connector

1. Remove the main battery from ET5X.
2. Install the battery cover.
3. Dip the cotton portion of the cotton tipped applicator in isopropyl alcohol.

4. Repeat at least three times.
5. Use the cotton tipped applicator dipped in alcohol to remove any grease and dirt near the connector area.
6. Use a dry cotton tipped applicator and repeat steps 3 through 6.
7. Spray compressed air on the connector area by pointing the tube/nozzle about ½ inch away from the surface.



CAUTION Do not point nozzle at yourself and others, ensure the nozzle or tube is away from your face.

8. Inspect the area for any grease or dirt, repeat if required.

Cleaning Cradle Connectors

Use this procedure to clean the connectors on a cradle:

1. Remove power from the cradle.
2. Dip the cotton portion of the cotton tipped applicator in isopropyl alcohol.
3. Rub the cotton portion of the cotton tipped applicator along the pins of the connector. Slowly move the applicator back-and-forth from one side of the connector to the other. Do not let any cotton residue on the connector.
4. All sides of the connector should also be rubbed with the cotton tipped applicator.
5. Spray compressed air in the connector area by pointing the tube/nozzle about ½ inch away from the surface.



CAUTION Do not point nozzle at yourself and others, ensure the nozzle or tube is pointed away from your face.

6. Ensure that there is no lint left by the cotton tipped applicator, remove lint if found.
7. If grease and other dirt can be found on other areas of the cradle, use lint free cloth and alcohol to remove.
8. Allow at least 10 to 30 minutes (depending on ambient temperature and humidity) for the alcohol to air dry before applying power to cradle.

If the temperature is low and humidity is high, longer drying time is required. Warm temperature and dry humidity requires less drying time.

Cleaning Frequency

The cleaning frequency is up to the customer's discretion due to the varied environments in which the ET5X units are used. They may be cleaned as frequently as required. However when used in dirty environments it may be advisable to periodically clean the scanner exit window to ensure optimum scanning performance.

Troubleshooting

Diagnostic Tool

The **Diagnostic Tool** is a powerful utility that determines the health of the ET5X, enabling our Device Diagnostic Service. Where appropriate, Zebra Help Desk uses the Diagnostic Tool for troubleshooting the device, relying on the results to provide you with the most optimum steps to reach a prompt resolution.

Refer to the ET5X Integrator Guide for Android Version 6.0.1 for more information.

ET5X

Table 13 Troubleshooting the ET5X

Problem	Cause	Solution
ET5X does not turn on.	Battery not charged.	Charge the battery in the ET5X.
	Battery not installed properly.	Ensure battery is installed properly.
	System crash.	Perform a soft reset. If the ET5X still does not turn on, perform a hard reset. See Rebooting the ET5X on page 52 .
Battery did not charge.	Battery failed.	Replace battery. If the ET5X still does not operate, try a soft reset, then a hard reset. See Rebooting the ET5X on page 52 .
	ET5X removed from cradle before charging completed.	Insert the ET5X into the cradle and begin charging. The battery fully charges in approximately four hours.
	Ambient temperature of the cradle is too warm or too cold.	The ambient temperature must be between 0°C and 40°C (32°F and 104°F).
Unable to connect to the wireless network.	SIM card is valid.	Ensure that the micro SIM card is valid and workable if using a mobile network.
	Not within range of network.	Move within the network's service range and the signal strength is good.
	ET55 is in airplane mode.	Ensure that ET55 is not in Airplane mode.
The multi-touch screen responds slowly or improperly.	Finger or screen is wet.	Ensure that your hands are clean and dry when touching the screen. Restart the tablet to try again.

Table 13 Troubleshooting the ET5X (Continued)

Problem	Cause	Solution
ET5X turns itself off.	ET5X is inactive.	The ET5X turns off after a period of inactivity. If the ET5X is running on battery power.
	Battery is depleted.	Place the ET5X in the cradle to re-charge the battery.
	The ET5X's battery is low and it powers down to protect memory content.	Place the ET5X in a cradle to re-charge the battery.
Screen is not rotating.	Screen rotation is disabled.	Enable screen rotation. See Display Setting on page 28 .
	Sensors are disabled.	Sensors are disabled by default. See Device Sensors on page 24 to enable sensors.

Charge Only Cradle

Table 14 Troubleshooting the Charge only Cradle

Symptom	Possible Cause	Solution
ET5X battery is not charging.	ET5X was removed from cradle or cradle was unplugged from AC power.	Ensure cradle is receiving power. Ensure ET5X is seated correctly. Confirm main battery is charging. The battery fully charges in approximately four hours.
	Battery is faulty.	Verify that other batteries charge properly. If so, replace the faulty battery.
	The ET5X is not fully seated in the cradle.	Remove and re-insert the ET5X into the cradle, ensuring it is firmly seated.
	Ambient temperature of the cradle is too warm or too cold.	Move the cradle to an area where the ambient temperature is between 0°C and 40°C (32°F and 104°F).

Communication and Charging Cradles

Table 15 Troubleshooting the Communication and Charging Cradles

Symptom	Possible Cause	Solution
ET5X battery is not charging.	ET5X was removed from cradle or cradle was unplugged from AC power.	Ensure cradle is receiving power. Ensure ET5X is seated correctly. Confirm main battery is charging. The battery fully charges in approximately four hours.
	Battery is faulty.	Verify that other batteries charge properly. If so, replace the faulty battery.
	The ET5X is not fully seated in the cradle.	Remove and re-insert the ET5X into the cradle, ensuring it is firmly seated.
	Ambient temperature of the cradle is too warm or too cold.	Move the cradle to an area where the ambient temperature is between 0°C and 40°C (32°F and 104°F).
During communication, no data transmits, or transmitted data was incomplete.	ET5X removed from cradle during communications.	Replace ET5X in cradle and retransmit.
	Incorrect cable configuration.	Ensure that the correct cable configuration.
ET5X does not lock into cradle.	Access cover closed.	Open ET5X access cover and re-insert ET5X onto cradle.
	ET5X with Rugged Frame and IO Adapter does not mate with Communication and Charging Cradle.	Use Rugged Communication and Charging Cradle.

Expansion Backs

Table 16 Troubleshooting the Expansion Backs

Symptom	Possible Cause	Solution
Aiming laser does not display when pressing trigger.	On 8" tablet, did not remove rubber gasket during installation.	See system administrator to re-install Expansion Back.
	ET5X is in suspend mode.	Press power button to wake the tablet.
	Battery is low.	If the scanner stops emitting a laser beam upon a scan button press, check the battery level. When the battery is low, the scanner shuts off before the ET5X low battery condition notification. Note: If the scanner is still not reading bar codes, contact system administrator.

Table 16 Troubleshooting the Expansion Backs (Continued)

Symptom	Possible Cause	Solution
Laser comes on, but scanner does not decode the bar code.	ET5X is not programmed for the bar code.	Ensure the application is programmed to read the type of bar code being scanned. Contact system administrator.
	Unreadable bar code.	Check the symbol to ensure it is not defaced. Try scanning another bar code of the same type.
	Distance between exit window and bar code is incorrect.	Move the ET5X within proper scanning range.
	Scanning application is not loaded.	Load a scanning application. See the system administrator.

4-Slot Charge Only Cradle

Table 17 Troubleshooting the 4-Slot Charge only Cradle

Symptom	Possible Cause	Solution
ET5X battery is not charging.	ET5X was removed from cradle or cradle was unplugged from AC power.	Ensure cradle is receiving power. Ensure ET5X is seated correctly. Confirm main battery is charging. The battery fully charges in approximately four hours.
	Battery is faulty.	Verify that other ET5X batteries charge properly. If so, replace the faulty battery.
	The ET5X is not fully seated in the cradle.	Remove and re-insert the ET5X into the cradle, ensuring it is firmly seated. Ensure that an insert is not used with ET5X with Rugged Frame. Ensure that an insert is used with ET5X without Rugged Frame.
	Ambient temperature of the cradle is too warm or too cold.	Move the cradle to an area where the ambient temperature is between 0°C and 40°C (32°F and 104°F).

Charging Adapter

Table 18 Troubleshooting the Charging Adapter

Symptom	Possible Cause	Solution
ET5X battery is not charging.	ET5X was removed from adapter or adapter was unplugged from AC power.	Ensure adapter is receiving power. Ensure ET5X is seated correctly. Confirm ET5X is charging. The battery fully charges in approximately four hours.
	Battery is faulty.	Verify that other ET5X batteries charge properly. If so, replace the faulty battery.
	The ET5X is not fully seated in the adapter.	Remove and re-insert the ET5X into the adapter, ensuring it is firmly seated.
	Ambient temperature of the adapter is too warm or too cold.	Move the adapter to an area where the ambient temperature is between 0°C and 40°C (32°F and 104°F).

4-Slot Battery Charger

Table 19 Troubleshooting the 4-Slot Battery Charger

Symptom	Possible Cause	Solution
Power Pack Charging LED does not light when inserted.	Power Pack is not correctly seated.	Remove and re-insert the spare battery into the charging slot, ensuring it is correctly seated.
Power Pack is not charging.	Power Pack was removed from charger or charger was unplugged from AC power.	Ensure charger is receiving power. Ensure Power Pack is seated correctly. Confirm Power Pack is charging. The Power Pack fully charges in approximately four hours.
	Power Pack is faulty.	Verify that other Power Pack charge properly. If so, replace the faulty Power Pack.
	The Power Pack is not fully seated in the charger.	Remove and re-insert the Power Pack into the charger, ensuring it is firmly seated.
	Ambient temperature of the charger is too warm or too cold.	Move the charger to an area where the ambient temperature is between 0°C and 40°C (32°F and 104°F).

Specifications

Technical Specifications

The following tables summarize the ET5X's intended operating environment and general technical hardware specifications.

ET5X

The following table summarizes the ET5X's intended operating environment.

Table 20 Technical Specifications

Item	Description
Physical and Environmental Characteristics	
Dimensions	8" Configuration: 228 mm W x 150 mm H x 12.5 mm D (9.0 in. L x 5.9 in. W x 0.5 in. H) 10" Configuration: (269 mm W x 181 mm H x 12.5 mm D) 10.6 in. L x 7.1 in. W x 0.5 in. H
Weight	8" Configuration: 555 g (1.2 lbs) 10" Configuration: 750 g (1.55 lbs)
Display	8" Configuration: 8.3 in (diagonal) 1920 x 1200 WUVGA with backlight 10" Configuration: 10.1 in (diagonal) 1920 x 1200 WUVGA with backlight
Touch panel	Capacitive 10 point multi-touch
Keypad Options	Virtual, Bluetooth or USB
Expansion	Integrated connector to easily add accessories

Specifications

Table 20 Technical Specifications (Continued)

Item	Description
Connectivity	Docking connector: USB 3.0, HDMI, charging; rugged connector for use with rugged dock Interfaces: full-size USB 2.0 connector, audio jack 3.5mm, microUSB (for communication with host computer)
Notification	LED flash; bar code decode; camera LED indicator
Audio	Stereo speakers and dual microphones (one front and one rear-facing)
Battery	8" Configuration: 5,900 mAh rechargeable Smart Li-Ion; user replaceable 10" Configuration: 8,700 mAh rechargeable Smart Li-Ion; user replaceable Optional hot swappable 3.6 VDC @ 6,800 mAh (24.4 Whr) secondary battery available for 8" and 10" ET5X.
Performance Characteristics	
CPU	Intel quad core 1.33GHz (Turbo Frequency = 1.86GHz) Frequency supports 32 bit OS
Operating System	Android Open Source Project (AOSP) version 6.0.1 or Google Mobile Services (GMS) version 6.0.1.
Memory	2 GB LPDDR3 RAM; 32 GB eMMC Flash; User accessible microSDXC card slot (standard supports up to 2 TB)
Data Capture	
Front Camera	2 MP 1080p full HD optimized for video and low lighting conditions.
Rear Camera	Image capture: 8MP auto-focus camera with user controllable LED flash, illumination; captures photographs and video.
Video	1080p (Full HD, 1920 x 1080), Frame rate = 30fps
Scanning	Optional SE4750 8" Expansion Back Optional SE4750 10" Expansion Back Optional RS507 Hands-free Imager Optional RS6000 Scanner (supported on BSP 02-14-30 and above) DS3608SR/ER USB scanners (supported on BSP 02-14-30 and above) DS3678 SR/ER Bluetooth scanners (supported on BSP 02-14-30 and above).
User Environment	
Operating Temperature	0°C to 50°C (32°F to 122°F)
Storage Temperature	-20°C to 60°C (-4°F to 140°F)
Battery Charging Temperature	0°C to +40°C (32°F to 104°F)

Specifications

Table 20 Technical Specifications (Continued)

Item	Description
Humidity	10% to 90% RH (non condensing)
Drop Specification	Standard: 1 m (3.28 ft.) drop to concrete without rugged frame. With optional rugged frame: 1.8 m (5.9 ft.) to concrete per MIL STD 810G. With optional Expansion Back: Per MIL STD 810G across operating temperatures.
Vibration	Operational: random vibration 10-1000 Hz 1.9g RMS, 1 hour duration per axis. Non-operational: random vibration 10-1000Hz, 4.1 g RMS
Environmental Sealing	IP65
ESD	+/-8kVdc air discharge +/-4kVdc direct discharge +/-4kVdc indirect discharge
WWAN Wireless Data Communications	
	Global LTE with HSPA+ North America: AT&T LTE with AT&T (HSPA+) 3G fallback; Verizon LTE with EVDO fallback
WLAN Wireless Data Communications	
WLAN radio	2x2 MIMO; IEEE 802.11a/b/g/n/ac/d/h/i.
Data Rate	2.4 GHz: 802.11b/g/n - up to 144 Mb per second 5 GHz: 802.11a/n/ac - up to 866.7 Mb per second
Operating Channels	Chan 1 - 13 (2412 - 2472 MHz), Chan 36 - 165 (5180 - 5825 MHz) Channel Bandwidth: 20, 40, 80 MHz Actual operating channels/frequencies depend on regulatory rules and certification agency.
Antenna	Dual band antennas for 2x2 MIMO
WLAN Security	WEP (40 or 104 bit); WPA/WPA2 Personal (TKIP and AES); WPA/WPA2 Enterprise (TKIP and AES) - EAP-TTLS (PAP, MSCHAP, MSCHAPv2), EAP-TLS, PEAPv0-MSCHAPv2, PEAPv1-EAP-GTC, EAP LEAP.
WPAN Wireless Data Communications	
Bluetooth	Class 2, Bluetooth v4.1 (Bluetooth® Smart)
Near Field Communication	P2P: ISO 18092 • Reader/Writer: ISO 14443 – A-B, MIFARE, FeliCa®, ISO 15693, NFC Forum Tag Types 1 to 4 • Card emulation: ISO 14443 – A-B-B', MIFARE, FeliCa RF • Distance up to 3 cm
GPS	GNSS supports both GPS and Glonass with LTO technology for Assisted-GPS without sacrificing autonomous operation.
Sensors	

Specifications

Table 20 Technical Specifications (Continued)

Item	Description
Gyroscope	Maintains orientation based on principles of conservation of angular momentum
Motion Sensor	3-axis accelerometer that enables motion-sensing applications for dynamic screen orientation and power management.
Ambient Light Sensor	Automatically adjusts display brightness, keypad and display backlight.
Electronic Compass	Independent — does not depend on GPS
Peripherals and Accessories	
Cradles	Charge Only Cradle Communication and Charging Cradles Rugged Communication Cradle 4-Slot Charge Only Cradle Charging Adapter 4-Slot Battery Charger
Printers	Supports extensive line of Zebra approved printers
Rugged Frame	Provides additional protection for the tablet.

Table 21 Expansion Back Supported Symbologies

Bar Code Type	Symbologies
1D	Bookland EAN, Chinese 2 of 5, Codabar, Code 11, Code 128, Code 32, Code 39, Code 93, Discrete 2 of 5, EAN-8, EAN-13, GS1-128, Interleaved 2 of 5, Inverse 1D, ISBT-128, ISSN EAN, Korean 2 of 5, MSI, Matrix 2 of 5, Trioptic Code 39, UCC Coupon Code, UPCA, UPCE, UPCE1.
2D	Aztec, Aztec Inverse, Composite AB, Composite C, Data Matrix, Data Matrix Inverse, Maxicode, Micro PDF417, Micro QR, PDF417, QR Code, QR Code Inverse, Han Xin, Han Xin Inverse
Postal	Australian Postal, Japan Postal, UK Postal, US Planet, US Postnet, Netherlands KIX Code, USPS 4CB/One Code/Intelligent Mail, UPU FICS Postal

Index

Numerics

2-D bar codes 99

A

accessories

charge only cradle 111
communication and charging cradle 114
four slot charge only cradle 126
rugged communication and charging cradle 118

airplane mode 27

albums 64

android version 10

application shortcuts 42

B

bar codes

two dimensional 99

battery charging temperature 141

battery usage 25

browser 44

build number 10

bullets 11

C

calculator 44

calendar 44

charge only cradle 111

cleaning 132

clock 44

communication and charging cradle 114

configurations 9

contacts 45

conventions

notational 11

CPU 141

cradles

charge only 111

communication and charging 114

four slot charge only 126

rugged communication and charging 118

D

data capture 9

imaging 99

two dimensional bar codes 99

datawedge 45

diagnostics 75

dimensions 140

display 9, 140

downloads 45

drop specification 142

DWDEmo 45

E

EAP 83

Elemex 75

email 45

ET5X configuration 16

F

file browser 45, 54

four slot charge only cradle 126

G

getting started 16

H

humidity 142

I

imager. *See* data capture, imaging

imaging 99

information, service 11

K	
keyboard	43
L	
lithium-ion battery	13
low battery notification	26
M	
main battery	
installing	16
maintenance	132
memory	9, 141
O	
operating environment, tablet	140
operating system	9, 141
operating temperature	141
P	
parts of the tablet	
front view	13
PEAP-GTC	83
PEAP-MSCHAPv2	83
photos	58
R	
radios	9
recording videos	59
related documents	11
related software	11
RS507 scanning	100
rugged communication and charging cradle	118
S	
scanning	97
angle	98
imaging	99
range	98
scanning considerations	98
serial number	10
set date	27
set time	27
set time zone	27
setting	
video	61
settings	47
sound recorder	47
specifications	140
starting the tablet	16
storage temperature	141
T	
technical specifications, tablet	140
TLS	83
troubleshooting	135
TTLS	
TTLS-MSCHAP	83
TTLS-MSCHAPv2	83
TTLS-PAP	83
U	
unpacking	13
V	
video settings	61
videos	58, 59
W	
weight	140
WEP	83
WLAN 802.11a/b/g/n	9, 10
WPA	83
WPAN Bluetooth	9, 10

